

# SPC-9000/9100/9200 USER Manual

Intel® Core™ Ultra Processors Ultra-Compact Fanless AI PC  
2 2.5G LAN, USB 3.2 Type-C, 2 COM, Rugged, -40°C to 75°C

# Record of Revision

---

Version	Date	Page	Description	Remark
1.00	2024/10/04	All	Official Release	

## Disclaimer

This manual is released by Vecow Co., Ltd. for reference purpose only. All product offerings and specifications are subject to change without prior notice. It does not represent commitment of Vecow Co., Ltd. Vecow shall not be liable for direct, indirect, special, incidental, or consequential damages arising out of the use of the product or documentation or any infringements upon the rights of third parties, which may result from such use.

## Declaration of Conformity

**FCC** This equipment has been tested and found to comply with the limits for a Class A digital device, pursuant to part 15 of the FCC Rules. These limits are designed to provide reasonable protection against harmful interference when the equipment is operated in a commercial environment. This equipment generates, uses, and can radiate radio frequency energy, and if it is not installed and used in accordance with the instruction manual, it may cause harmful interference to radio communications. Operation of this equipment in a residential area is likely to cause harmful interference in which case the user will be required to correct the interference at his own expense.

**CE** The products described in this manual complies with all applicable European Union (CE) directives if it has a CE marking. For computer systems to remain CE compliant, only CE-compliant parts may be used. Maintaining CE compliance also requires proper cable and cabling techniques.

## Copyright and Trademarks

This document contains proprietary information protected by copyright. No part of this publication may be reproduced in any form or by any means, electric, photocopying, recording or otherwise, without prior written authorization by Vecow Co., Ltd. The rights of all the brand names, product names, and trademarks belong to their respective owners.

# Order Information

Part Number	Description
SPC-9000-165U	SPC-9000, onboard Intel® Core™ Ultra 7 165U with heat spreader, 2 2.5G LAN, 1 SSD, 1 USB 3.2 Gen 2x2 Type-C with DP function, 2 USB 3.2 Gen 2 Type-A, 2 COM RS-232/422/485, 1 HDMI, 1 DP, 1 Nano SIM, 9V to 55V DC-in
SPC-9000-135U	SPC-9000, onboard Intel® Core™ Ultra 5 135U with heat spreader, 2 2.5G LAN, 1 SSD, 1 USB 3.2 Gen 2x2 Type-C with DP function, 2 USB 3.2 Gen 2 Type-A, 2 COM RS-232/422/485, 1 HDMI, 1 DP, 1 Nano SIM, 9V to 55V DC-in
SPC-9100-165U	SPC-9100, onboard Intel® Core™ Ultra 7 165U with heat sink, 2 2.5G LAN, 1 SSD, 1 USB 3.2 Gen 2x2 Type-C with DP function, 2 USB 3.2 Gen 2 Type-A, 2 COM RS-232/422/485, 1 HDMI, 1 DP, 1 Nano SIM, 9V to 55V DC-in
SPC-9100-135U	SPC-9100, onboard Intel® Core™ Ultra 5 135U with heat sink, 2 2.5G LAN, 1 SSD, 1 USB 3.2 Gen 2x2 Type-C with DP function, 2 USB 3.2 Gen 2 Type-A, 2 COM RS-232/422/485, 1 HDMI, 1 DP, 1 Nano SIM, 9V to 55V DC-in
SPC-9200-165U	SPC-9200, onboard Intel® Core™ Ultra 7 165U with fan sink, 2 2.5G LAN, 1 SSD, 1 USB 3.2 Gen 2x2 Type-C with DP function, 2 USB 3.2 Gen 2 Type-A, 2 COM RS-232/422/485, 1 HDMI, 1 DP, 1 Nano SIM, 9V to 55V DC-in
SPC-9200-135U	SPC-9200, onboard Intel® Core™ Ultra 5 135U with fan sink, 2 2.5G LAN, 1 SSD, 1 USB 3.2 Gen 2x2 Type-C with DP function, 2 USB 3.2 Gen 2 Type-A, 2 COM RS-232/422/485, 1 HDMI, 1 DP, 1 Nano SIM, 9V to 55V DC-in



## Optional Accessories

---

Part Number	Description
DDR5 48G	Certified DDR5 48GB 5600MHz RAM
DDR5 32G	Certified DDR5 32GB 4800/5600MHz RAM
DDR5 24G	Certified DDR5 24GB 5600MHz RAM
DDR5 16G	Certified DDR5 16GB 4800/5600MHz RAM
DDR5 8G	Certified DDR5 8GB 4800/5600MHz RAM
PWA-120W1	120W, 24V, 90V AC to 264V AC Power Adapter with 3-pin Terminal Block
VESA Mount	VESA Mounting Kit
DIN-RAIL	DIN Rail Kit
M.2 Storage Module	M.2 Key M/Key B Storage Module
5G Module	5G Module with Antenna
4G Module	4G/GPS Module with Antenna
WiFi & Bluetooth Module	WiFi & Bluetooth Module with Antenna

# Table of Contents

<b>CHAPTER 1</b>	<b>GENERAL INTRODUCTION</b>	<b>1</b>
1.1	Overview	1
1.2	Features	2
1.3	Product Specification	3
1.3.1	Specifications of SPC-9000	3
1.3.2	Specifications of SPC-9100	5
1.3.3	Specifications of SPC-9200	7
1.4	Mechanical Dimension	9
1.4.1	SPC-9000 Mechanical Drawing	9
1.4.2	SPC-9100 Mechanical Drawing	9
1.4.3	SPC-9200 Mechanical Drawing	10
<b>CHAPTER 2</b>	<b>GETTING TO KNOW YOUR SPC-9000</b>	<b>11</b>
2.1	SPC-9000/9100/9200 Packing List	11
2.2	Front Panel I/O & Functions	12
2.3	Rear Panel I/O & Functions	17
2.4	Main Board Expansion Connectors	19
2.5	Main Board Jumper Settings	36
2.6	Ignition Control	39
<b>CHAPTER 3</b>	<b>SYSTEM SETUP</b>	<b>42</b>
3.1	How to Open Your SPC-9000	42
3.2	Installing DDR5 SO-DIMM Module	44
3.3	Installing SIM Card	45
3.4	Installing M.2	46
3.5	Installing SSD/HDD	47
3.6	Installing Antenna Cable	48
3.7	Mounting Your SPC-9000	49

<b>CHAPTER 4</b>	<b>BIOS SETUP</b>	<b>50</b>
4.1	BIOS Setting	50
4.2	Main Menu	51
4.3	Advanced Menu	52
4.4	Security	62
4.5	Boot Menu	63
4.6	Save & Exit	64
<b>APPENDIX A</b>	<b>: GPIO GUIDE</b>	<b>65</b>
<b>APPENDIX B</b>	<b>: Software Functions</b>	<b>68</b>
<b>APPENDIX C</b>	<b>: RAID Functions</b>	<b>71</b>
<b>APPENDIX D</b>	<b>: Power Consumption</b>	<b>78</b>
<b>APPENDIX E</b>	<b>: Supported Memory &amp; Storage List</b>	<b>80</b>

# 1

## GENERAL INTRODUCTION

### 1.1 Overview

The Vecow SPC-9000 Series is an ultra-compact and fanless AI PC powered by Intel® Core™ Ultra Processor, which integrates multiple compute engines—P-cores, E-cores, LP E-cores, Intel® Graphics, and Intel® AI Boost—into a single SoC. The SPC-9000 accelerates the innovation of Edge AI applications across diverse industries, including factory management, data acquisition & monitoring, AMR, smart retail, and other Edge AI applications.

The SPC-9000 Series is equipped with high-speed interfaces, including 2 2.5G LAN, 2 USB 3.2 Gen 2 ports, and 1 USB 3.2 Gen 2x2 Type-C port. It supports multiple displays: 1 HDMI 2.1, 1 DisplayPort 1.4, and 1 DisplayPort 1.4 via USB Type-C. The system's optional SUMIT socket further expands its capabilities, enabling support for 10GigE LAN, 10G SFP+, and 4G networks connections through the SIM socket. These features enhance the SPC-9000's power efficiency and graphics performance, making it ideal for AI vision applications.

Designed to withstand harsh industrial environments, the SPC-9000 Series supports a wide range of power inputs from 9V to 55V and operates reliably within an extended temperature range from -40°C to 75°C. These designs ensure the system's durability, reliability, and resilience, making it a good choice for mission-critical applications.

## 1.2 Features

- Intel® Core™ Ultra processors feature a hybrid CPU/GPU/NPU architecture, improving CPU productivity by up to 14%.
- Intel® AI Boost NPU delivers 11 TOPS AI-focused performance
- Compact Design, fanless -40°C to 75°C Operation
- DC 9V to 55V Power Input, Software Ignition Power Control
- 2 USB 3.2 Gen 2, 1 USB 3.2 Gen 2x2 Type-C with DP, HDMI 2.1 and DisplayPort 1.4 support up to 4K resolution
- 2 2.5G LAN, 3 M.2 Socket for storage and expansion
- Optional SUMIT B expansions for 10GigE LAN, 10G SFP+, or 4G Networks.
- Supports Intel® vPro, TSN, TCC, and TPM 2.0
- Optional VHub One-Stop AIoT Solution Service supports OpenVINO™ toolkit for AI Computing

## 1.3 Product Specification

### 1.3.1 Specifications of SPC-9000

<b>System</b>	
Processor	Intel® Core™ Ultra 7/5 Processor (Meteor Lake-U)
NPU	Intel® AI Boost
Chipset	Intel® SoC
BIOS	AMI
SIO	IT8786E
Memory	1 DDR5 5600MHz SO-DIMM, up to 48GB
<b>Graphics</b>	
Graphics Processor	Intel® Iris® Xe Graphics
Interface	Supports Triple Display : <ul style="list-style-type: none"> <li>• 1 HDMI 2.1 : Up to 4096 x 2304 @60Hz</li> <li>• 1 DisplayPort 1.4 : Up to 4096 x 2304 @60Hz</li> <li>• 1 DisplayPort 1.4 : Up to 4096 x 2304 @60Hz by USB Type-C</li> </ul>
<b>Ethernet</b>	
LAN 1	Intel® I226 2.5G LAN supports TSN
LAN 2	Intel® I226 2.5G LAN supports TSN
<b>Audio</b>	
Audio Codec	Realtek ALC888S-VD, 7.1 Channel HD Audio
Audio Interface	1 Mic-in, 1 Line-out
<b>Storage</b>	
SATA	1 SATA III (6Gbps)
M.2	<ul style="list-style-type: none"> <li>• 1 M.2 Key M Socket (2280, PCIe 4.0 x4)</li> <li>• 1 M.2 Key B Socket (2242, PCIe x2/USB 2)</li> </ul>
Storage Device	1 2.5" SSD/HDD Bracket (Internal)
<b>I/O Interface</b>	
Serial	2 COM RS-232/422/485 (ESD 8kV)
USB	<ul style="list-style-type: none"> <li>• 1 USB 3.2 Gen 2x2 Type-C support max 20Gbps and DP 1.4(5V/3A)</li> <li>• 2 USB 3.2 Gen 2 Type-A</li> </ul>
LED	Power, HDD, WWAN, WLAN
SIM Card	1 Nano SIM Card Socket (External)
<b>Expansion</b>	
M.2	<ul style="list-style-type: none"> <li>• 1 M.2 Key B Socket (3042/3052, PCIe x2/USB 3 Default/USB 2)</li> <li>• 1 M.2 Key E Socket (2230, PCIe x1/USB2)</li> </ul>
SUMIT	<ul style="list-style-type: none"> <li>• 1 SUMIT B Connector (Optional, with customized chassis)</li> </ul>

<b>Power</b>	
Power Input	9V to 55V DC-in
Power Interface	3-pin Terminal Block : V+, V-, Frame Ground
Ignition Control	16-mode Software Ignition Control
Remote Switch	3-pin Terminal Block : On, Off, IGN
<b>Others</b>	
TPM	Infineon SLB9672 supports TPM 2.0, SPI Interface
Watchdog Timer	Reset : 1 to 255 sec./min. per step
HW Monitor	Wake on LAN, PXE supported
Ignition Control	Monitoring temperature, voltages. Auto throttling control when CPU overheats.
<b>Software Support</b>	
OS	Windows 11, Windows 10, Linux
<b>Mechanical</b>	
Dimension (W x L x H)	150.4mm x 106.2mm x 44.2mm (5.92" x 4.18" x 1.74")
Weight	0.9 kg (1.98 lb)
Mounting	<ul style="list-style-type: none"> <li>• Wallmount by mounting bracket</li> <li>• DIN Rail Mount (Optional)</li> <li>• VESA Mount (Optional)</li> </ul>
<b>Environment</b>	
Operating Temperature	-40°C to 60°C (-40°F to 140°F) with air flow
Storage Temperature	-40°C to 85°C (-40°F to 185°F)
Humidity	5% to 95% Humidity, non-condensing
Relative Humidity	95% at 60°C
Shock	<ul style="list-style-type: none"> <li>• IEC 60068-2-27</li> <li>• SSD : 50G @wallmount, Half-sine, 11ms</li> </ul>
Vibration	<ul style="list-style-type: none"> <li>• IEC 60068-2-64</li> <li>• SSD : 5Grms, 5Hz to 500Hz, 3 Axis</li> </ul>
EMC	CE, FCC, ICES, EN50155, EN50121-3-2

### 1.3.2 Specifications of SPC-9100

<b>System</b>	
Processor	Intel® Core™ Ultra 7/5 Processor (Meteor Lake-U)
NPU	Intel® AI Boost
Chipset	Intel® SoC
BIOS	AMI
SIO	IT8786E
Memory	1 DDR5 5600MHz SO-DIMM, up to 48GB
<b>Graphics</b>	
Graphics Processor	Intel® Iris® X <sup>e</sup> Graphics
Interface	Supports Triple Display : <ul style="list-style-type: none"> <li>• 1 HDMI 2.1 : Up to 4096 x 2304 @60Hz</li> <li>• 1 DisplayPort 1.4 : Up to 4096 x 2304 @60Hz</li> <li>• 1 DisplayPort 1.4 : Up to 4096 x 2304 @60Hz by USB Type-C</li> </ul>
<b>Ethernet</b>	
LAN 1	Intel® I226 2.5G LAN supports TSN
LAN 2	Intel® I226 2.5G LAN supports TSN
<b>Audio</b>	
Audio Codec	Realtek ALC888S-VD, 7.1 Channel HD Audio
Audio Interface	1 Mic-in, 1 Line-out
<b>Storage</b>	
SATA	1 SATA III (6Gbps)
M.2	<ul style="list-style-type: none"> <li>• 1 M.2 Key M Socket (2280, PCIe 4.0 x4)</li> <li>• 1 M.2 Key B Socket (2242, PCIe x2/USB 2)</li> </ul>
Storage Device	1 2.5" SSD/HDD Bracket (Internal)
<b>I/O Interface</b>	
Serial	2 COM RS-232/422/485 (ESD 8kV)
USB	<ul style="list-style-type: none"> <li>• 1 USB 3.2 Gen 2x2 Type-C support max 20Gbps and DP 1.4(5V/3A)</li> <li>• 2 USB 3.2 Gen 2 Type-A</li> </ul>
LED	Power, HDD, WWAN, WLAN
SIM Card	1 External Nano SIM Card Socket
<b>Expansion</b>	
M.2	<ul style="list-style-type: none"> <li>• 1 M.2 Key B Socket (3042/3052, PCIe x2/USB 3 Default/USB 2)</li> <li>• 1 M.2 Key E Socket (2230, PCIe x1/USB2)</li> </ul>
SUMIT	<ul style="list-style-type: none"> <li>• 1 SUMIT B Connector (Optional, with customized chassis)</li> </ul>



<b>Power</b>	
Power Input	9V to 55V DC-in
Power Interface	3-pin Terminal Block : V+, V-, Frame Ground
Ignition Control	16-mode Software Ignition Control
Remote Switch	3-pin Terminal Block : On, Off, IGN
<b>Others</b>	
TPM	Infineon SLB9672 supports TPM 2.0, SPI Interface
Watchdog Timer	Reset : 1 to 255 sec./min. per step
Smart Management	Wake on LAN, PXE supported
HW Monitor	Monitoring temperature, voltages. Auto throttling control when CPU overheats.
<b>Software Support</b>	
OS	Windows 11, Windows 10, Linux
<b>Mechanical</b>	
Dimension (W x L x H)	150.4mm x 106.2mm x 57.0mm (5.92" x 4.18" x 2.24")
Weight	1.3 kg (2.87 lb)
Mounting	<ul style="list-style-type: none"> <li>• Wallmount by mounting bracket</li> <li>• DIN Rail Mount (Optional)</li> <li>• VESA Mount (Optional)</li> </ul>
<b>Environment</b>	
Operating Temperature	-40°C to 75°C (-40°F to 167°F) with air flow
Storage Temperature	-40°C to 85°C (-40°F to 185°F)
Humidity	5% to 95% Humidity, non-condensing
Relative Humidity	95% at 75°C
Shock	<ul style="list-style-type: none"> <li>• IEC 60068-2-27</li> <li>• SSD : 50G @wallmount, Half-sine, 11ms</li> </ul>
Vibration	<ul style="list-style-type: none"> <li>• IEC 60068-2-64</li> <li>• SSD : 5Grms, 5Hz to 500Hz, 3 Axis</li> </ul>
EMC	CE, FCC, ICES, EN50155, EN50121-3-2

### 1.3.3 Specifications of SPC-9200

<b>System</b>	
Processor	Intel® Core™ Ultra 7/5 Processor (Meteor Lake-U)
NPU	Intel® AI Boost
Chipset	Intel® SoC
BIOS	AMI
SIO	IT8786E
Memory	1 DDR5 5600MHz SO-DIMM, up to 48GB
<b>Graphics</b>	
Graphics Processor	Intel® Iris® X <sup>e</sup> Graphics
Interface	Supports Triple Display : <ul style="list-style-type: none"> <li>• 1 HDMI 2.1 : Up to 4096 x 2304 @60Hz</li> <li>• 1 DisplayPort 1.4 : Up to 4096 x 2304 @60Hz</li> <li>• 1 DisplayPort 1.4 : Up to 4096 x 2304 @60Hz by USB Type-C</li> </ul>
<b>Ethernet</b>	
LAN 1	Intel® I226 2.5G LAN supports TSN
LAN 2	Intel® I226 2.5G LAN supports TSN
<b>Audio</b>	
Audio Codec	Realtek ALC888S-VD, 7.1 Channel HD Audio
Audio Interface	1 Mic-in, 1 Line-out
<b>Storage</b>	
SATA	1 SATA III (6Gbps)
M.2	<ul style="list-style-type: none"> <li>• 1 M.2 Key M Socket (2280, PCIe 4.0 x4)</li> <li>• 1 M.2 Key B Socket (2242, PCIe x2/USB 2)</li> </ul>
Storage Device	1 2.5" SSD/HDD Bracket (Internal)
<b>I/O Interface</b>	
Serial	2 COM RS-232/422/485 (ESD 8kV)
USB	<ul style="list-style-type: none"> <li>• 1 USB 3.2 Gen 2x2 Type-C support max 20Gbps and DP 1.4(5V/3A)</li> <li>• 2 USB 3.2 Gen 2 Type-A</li> </ul>
LED	Power, HDD, WWAN, WLAN
SIM Card	1 External Nano SIM Card Socket
<b>Expansion</b>	
M.2	<ul style="list-style-type: none"> <li>• 1 M.2 Key B Socket (3042/3052, PCIe x2/USB 3 Default/USB 2)</li> <li>• 1 M.2 Key E Socket (2230, PCIe x1/USB2)</li> </ul>
SUMIT	<ul style="list-style-type: none"> <li>• 1 SUMIT B Connector (Optional, with customized chassis)</li> </ul>

<b>Power</b>	
Power Input	9V to 55V DC-in
Power Interface	3-pin Terminal Block : V+, V-, Frame Ground
Ignition Control	16-mode Software Ignition Control
Remote Switch	3-pin Terminal Block : On, Off, IGN
<b>Others</b>	
TPM	Infineon SLB9672 supports TPM 2.0, SPI Interface
Watchdog Timer	Reset : 1 to 255 sec./min. per step
Smart Management	Wake on LAN, PXE supported
HW Monitor	Monitoring temperature, voltages. Auto throttling control when CPU overheats.
<b>Software Support</b>	
OS	Windows 11, Windows 10, Linux
<b>Mechanical</b>	
Dimension (W x L x H)	150.4mm x 106.2mm x 61.2mm (5.92" x 4.18" x 2.41")
Weight	1.4 kg (3.09 lb)
Mounting	<ul style="list-style-type: none"> <li>• Wallmount by mounting bracket</li> <li>• DIN Rail Mount (Optional)</li> <li>• VESA Mount (Optional)</li> </ul>
<b>Environment</b>	
Operating Temperature	-40°C to 70°C (-40°F to 158°F) with fan sink
Storage Temperature	-40°C to 85°C (-40°F to 185°F)
Humidity	5% to 95% Humidity, non-condensing
Relative Humidity	95% at 70°C
Shock	<ul style="list-style-type: none"> <li>• IEC 60068-2-27</li> <li>• SSD : 50G @wallmount, Half-sine, 11ms</li> </ul>
Vibration	<ul style="list-style-type: none"> <li>• IEC 60068-2-64</li> <li>• SSD : 5Grms, 5Hz to 500Hz, 3 Axis</li> </ul>
EMC	CE, FCC, ICES, EN50155, EN50121-3-2

# 1.4 Mechanical Dimension

## 1.4.1 SPC-9000 Mechanical Drawing

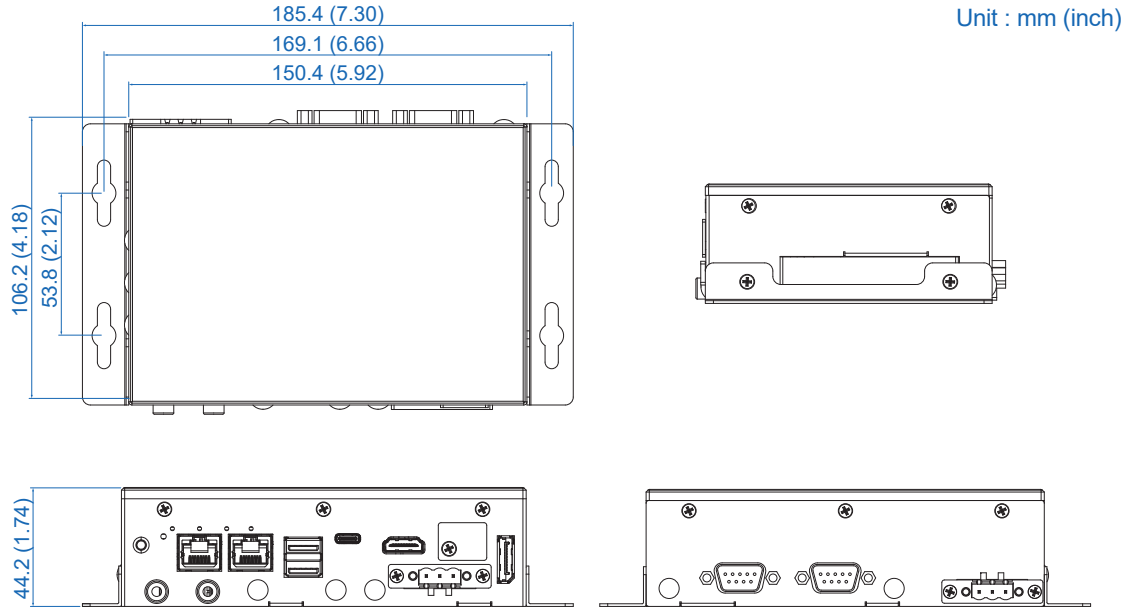

## 1.4.2 SPC-9100 Mechanical Drawing

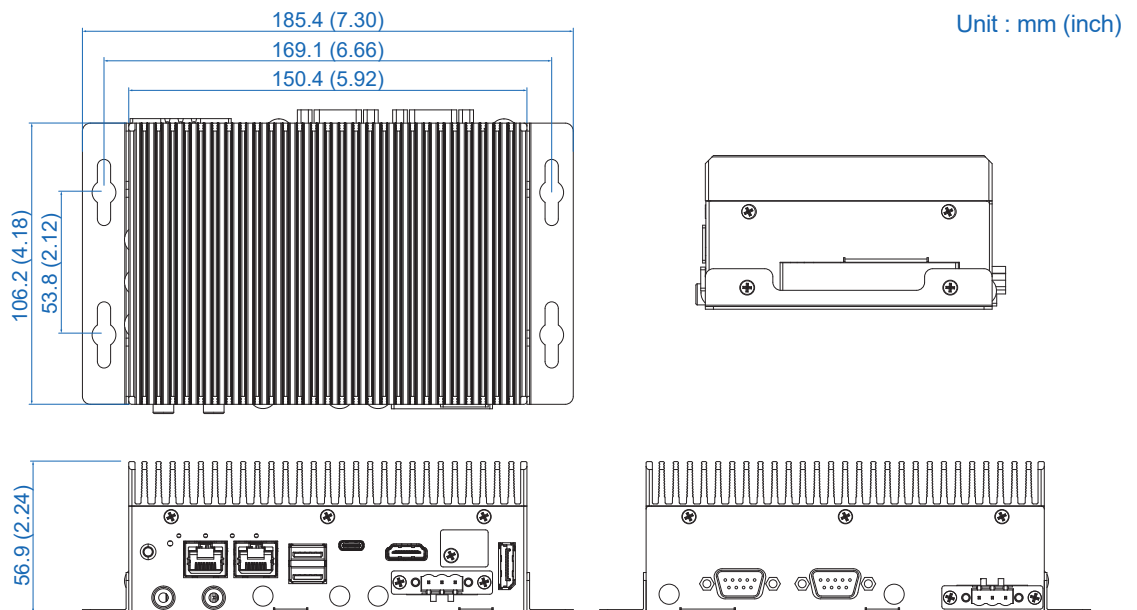

### 1.4.3 SPC-9200 Mechanical Drawing

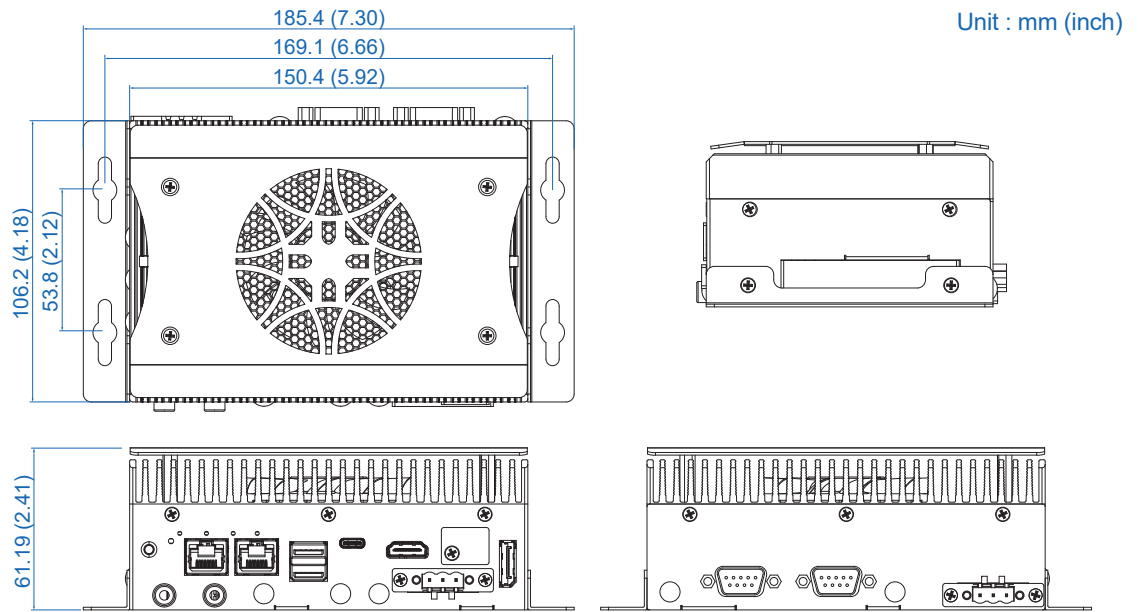

# 2

## GETTING TO KNOW YOUR SPC-9000

### 2.1 SPC-9000/9100/9200 Packing List

Item	Description	Qty
1	SPC-9000/9100/9200/ Embedded System	1

Item	Description	Outlook	Usage	P/N	Qty
1	PHILLPIS M3x6L		M.2	53-2426206-80B	3
2	Wall-mounting bracket		Mount	62-03P1629-75A	2
3	Terminal block plug pitch 5.0mm 3-pin		DC IN/Switch	51-2211R03-S1A	2
4	Foot Pad		Foot Pad	53-4000042-303	4
5	Flat M3x4L, Ni		Wall mount / HDD	53-M006350-010	8
6	PHILLPIS M3x4L		M.2	53-2426204-80B	1
7	M.2 Tray		M.2	62-01P0973-00B	1

## 2.2 Front Panel I/O & Functions

### 2.2.1 SPC-9000/9100/9200 Front I/O & Functions

In Vecow's SPC-9000 series family, all I/O connectors are located on the front panel. Most of the general connections to the computer device, such as Audio, USB3.2, USB Type C, LAN Jack, HDMI, Display Port and Nano-SIM Card Socket are placed on the front panel.

### 2.2.2 Reset Tact Switch

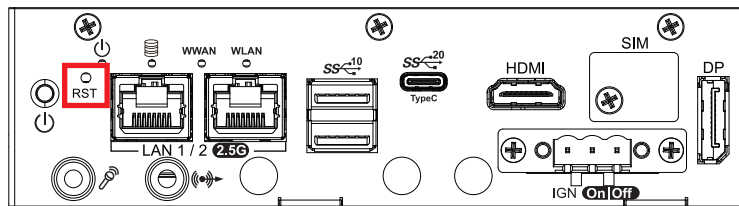

It is a hardware reset switch. Use this switch to reset the system without power off the system. Press the Reset Switch for a few seconds, then reset will be enabled.

### 2.2.3 Power Button

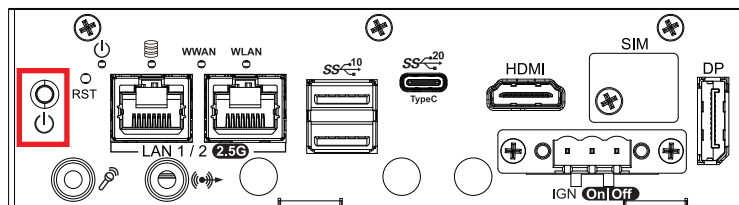

The power button is a non-latched switch. In case of system halts, you can press and hold the power button for 4 seconds to compulsorily shut down the system. Please note that a 4 seconds interval is kept by the system between two on/off operations (i.e. once turning off the system, you shall wait for 4 seconds to initiate another power-on operation).

### 2.2.4 PWR, HDD, WWAN, WLAN LED Indicator

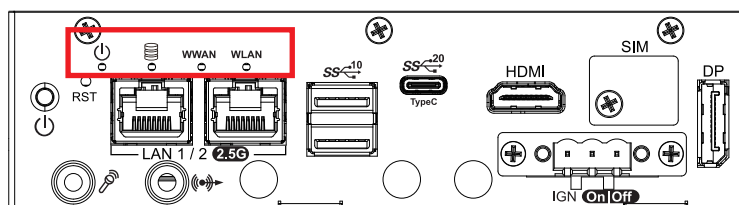

**Yellow-HDD LED** : A hard disk LED. If the LED is on, it indicates that the system's storage is functional. If it is off, it indicates that the system's storage is not functional. If it is flashing, it indicates data access activities are in progress.

**Green-Power LED** : If the LED is solid green, it indicates that the system is powered on.

**Green-WWAN LED** : If the LED is solid green, it indicates that the device on M2 key-B Socket is working.

**Green-WLAN LED** : If the LED is solid green, it indicates that the device on M2 key-E Socket is working.

LED Color	Indication	System Status
Yellow	HDD	<ul style="list-style-type: none"> <li>• On/Off : Storage is functional or not</li> <li>• 2.Twinkling : Data transferring</li> </ul>
Green	POWER	System power is on or off
Green	WWAN	Device is working or not
Green	WLAN	Device is working or not

## 2.2.5 DisplayPorts

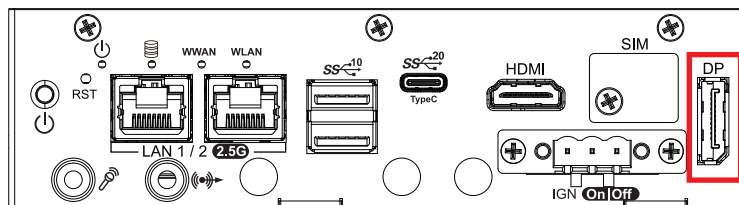

DisplayPort connection supports up to 4096 x 2304 resolution at 60Hz.

## 2.2.6 HDMI

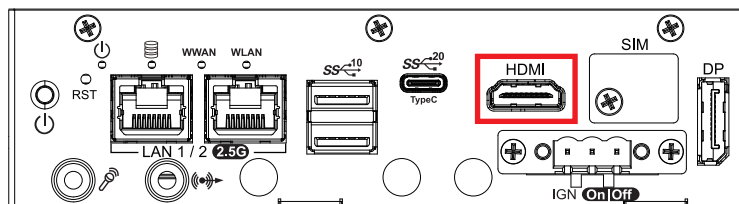

HDMI connection supports up to 4096 x 2304 resolution at 60Hz.



## 2.2.7 USB 3.2 Gen2

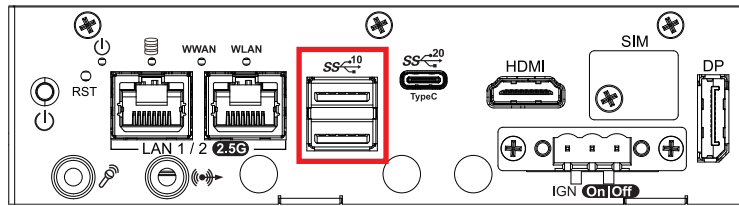

There are 2 USB 3.2 Gen2 ports connection available supporting up to 10GB per second data rate in the front side of SPC-9000 series. It also compliant with the requirements of Super Speed (SS), high speed (HS), full speed (FS) and low speed (LS).

## 2.2.8 USB Type C

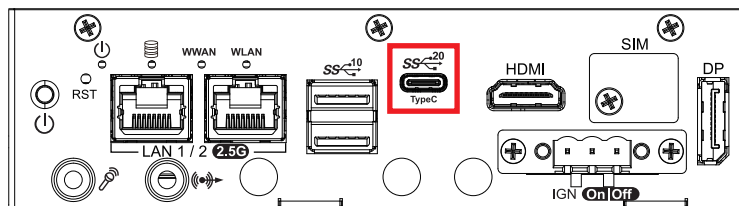

USB Type-C connector support up to 20GB per second data rate and DisplayPort 1.4a : Up to 3840 x 2160 @ 60Hz by USB Type-C in the front side of SPC-9000 series.

## 2.2.9 Audio Jack

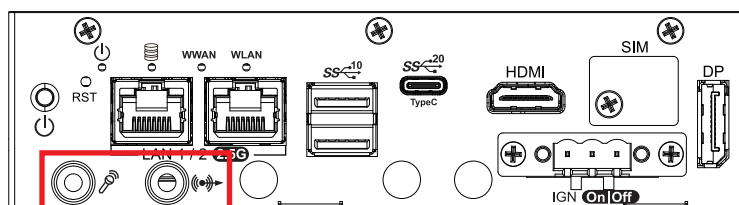

There are 2 audio connectors, Mic-in and Line-out, in the front side of SPC-9000 series. Onboard Realtek ALC888 audio codec supports 5.1 channel HD audio and fully complies with Intel® High Definition Audio (Azalia) specifications. To utilize the audio function in Windows platform, you need to install corresponding drivers for Realtek ALC888 codec.

## 2.2.10 100/1000/2500 Mbps Ethernet Port

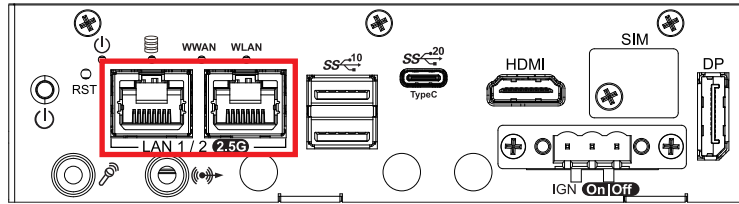

There are two 8-pin RJ-45 jacks supporting 100/1000/2500 Mbps Ethernet connections in the top side of SPC-9000. LAN1\_CON and LAN2\_CON is powered by Intel® I226-IT Ethernet engine.

Using suitable RJ-45 cable, you can connect SPC-9000 system to a computer or to any other devices with Ethernet connection, for example, a hub or a switch. Moreover, both LAN1 and LAN2 support Wake on LAN and Pre-boot functions. The pinouts of LAN1\_CON and LAN2\_CON are listed as follow:

Pin No.	100Mbps	1000Mbps	2500Mbps
1	E_TX+	MDI0_P	MDI0_P
2	E_TX-	MDI0_N	MDI0_N
3	E_RX+	MDI1_P	MDI1_P
4	-----	MDI2_P	MDI2_P
5	-----	MDI2_N	MDI2_N
6	E_RX-	MDI1_N	MDI1_N
7	-----	MDI3_P	MDI3_P
8	-----	MDI3_N	MDI3_N

Each LAN port is supported by standard RJ-45 connector with LED indicators to present Active/Link/Speed status of the connection.

LED Location	LED Color	10Mbps	100Mbps	1000Mbps
Right	Green/Orange	Off	Solid Green	Solid Orange
Left	Yellow	Twinkling Yellow	Twinkling Yellow	Twinkling Yellow

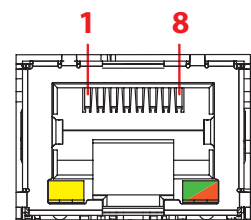

The LED indicator on the right top corner of LAN\_CON and LAN2\_CON lightens in solid orange when the cable is properly connected to a 2500 Mbps Ethernet network; the LED indicator on the right top corner of LAN1\_CON and LAN2\_CON lightens in solid green when the cable is properly connected to a 1000 Mbps Ethernet network; the LED indicator on the Left top corner of LAN1\_CON and LAN2\_CON will keep twinkling/ off when Ethernet data packets are being transmitted/ received.

## 2.2.11 Remote Power On/Off Switch and Ignition Control

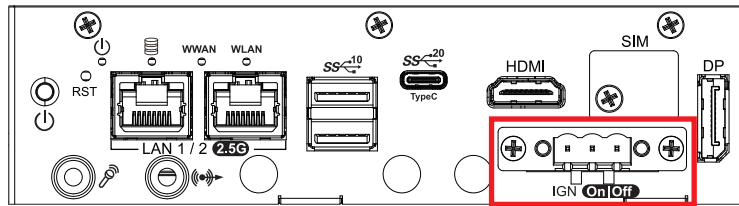

It is a 3-pin power-on/power-off switch through Phoenix Contact terminal block. You could turn on or off the system power by using this contact. This terminal block supports dual function on soft power-on/power-off (instant off or delay four seconds), and suspend mode. Another function is provided ignition power control feature for in-vehicle applications. The built-in MCU monitors the ignition signal and turns on/off the system according to pre-defined on/off delay period.

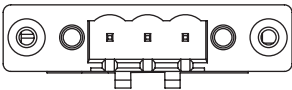
	Pin No.	Definition
	1	Ignition (IGN)
	2	SW+
	3	SW-

## 2.2.12 Nano SIM Card

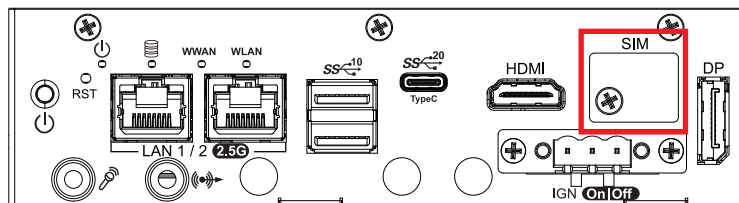

The Nano SIM card socket is support Push-Push type. Please make sure to unplug the system power before inserting the Nano SIM card.

## 2.3 Rear Panel I/O & Functions

### 2.3.1 SPC-9000/9100/9200 Rear I/O & Functions

In Vecow's SPC-9000 series family, some of the general connections to the computer device, such as DC-Input power connector, Serial ports and Nano-SIM Card Socket are placed on the rear panel.

### 2.3.2 Power Terminal Block

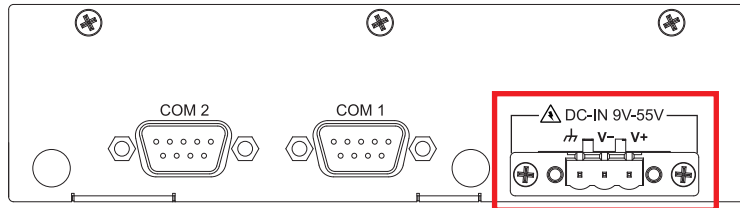

SPC-9000/9100/9200 supports 9V to 55V DC power input.

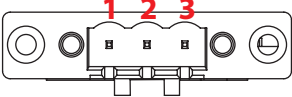
	Pin No.	Definition
	1	V+
	2	V-
	3	Earth GND

### 2.3.3 Serial Port COM

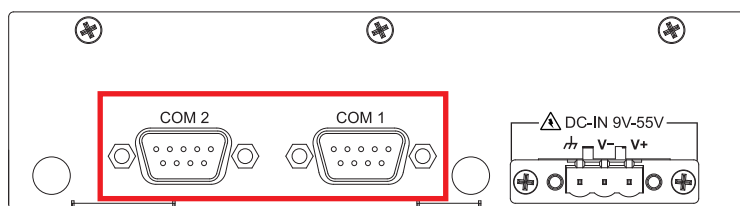

Serial port can be configured for RS-232, RS-422, or RS-485 with auto flow control communication. The default definition is RS-232, but if you want to change to RS-422 or RS-485, you can find the settings in BIOS.

COM 1 COM 2	Function
	RS-232
	RS-422 (5-wire)
	RS-485
	RS-485 w/z auto-flow control

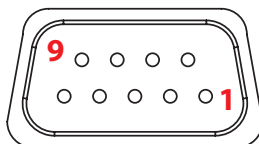

The pin assignments are listed in the table as follow :

Serial Port	Pin No.	RS-232	RS-422 (5-wire)	RS-485 (3-wire)
1 to 4	1	DCD	TXD-	DATA-
	2	RXD	TXD+	DATA+
	3	TXD	RXD+	-----
	4	DTR	RXD-	-----
	5	GND	GND	GND
	6	DSR	-----	-----
	7	RTS	-----	-----
	8	CTS	-----	-----
	9	RI	-----	-----

## 2.4 Main Board Expansion Connectors

### 2.4.1 SPC-9000/9100/9200 Main Board Top Side View

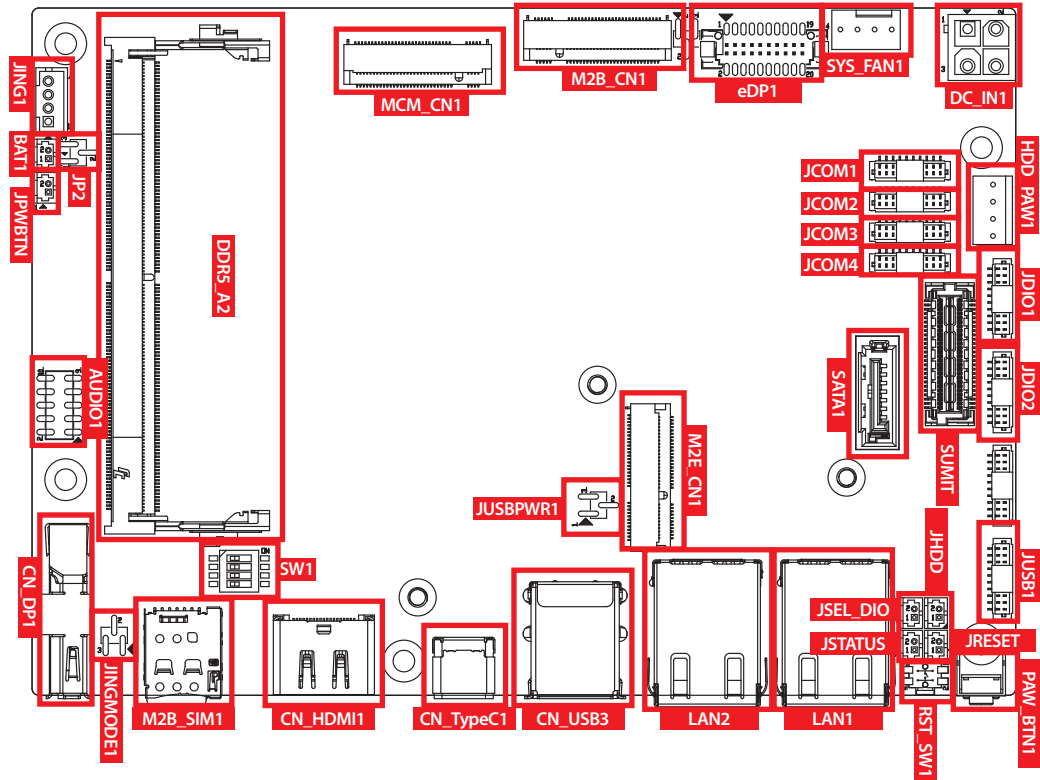

### 2.4.2 SPC-9000/9100/9200 Main Board Bottom Side View

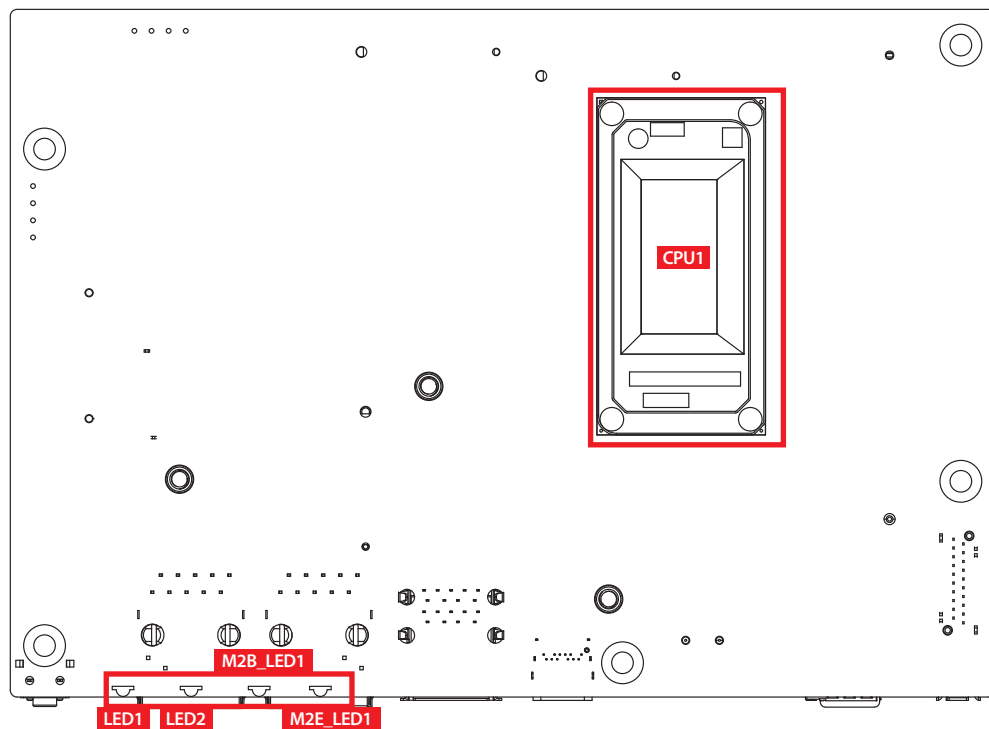

### 2.4.3 JPWBTN, JRESET, JSTATUS, JHDD : Miscellaneous Pin Header

These pin headers can be used as a backup for the following functions : hard drive, LED indicator, reset button, power LED indicator, and power on/off buttons, which already can be accessed by front panel and top panel. The pinouts of Miscellaneous port are listed in following table :

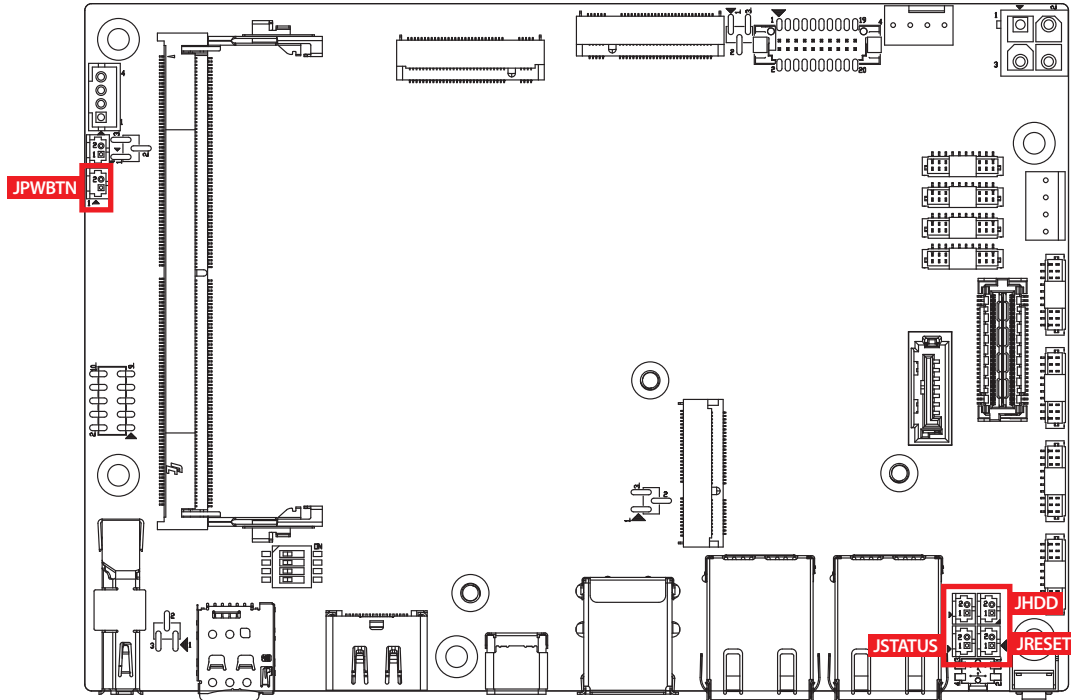

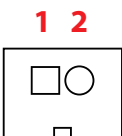
	Group	Pin No.	Description
	JPWBTN	1	GND
2		FP_PWR_BTN_IN	
JRESET	1	GND	
	2	FP_RST_BTN_N	
JSTATUS	1	PWR_LED_P	
	2	PWR_LED_N	
JHDD	1	HDD_LED_P	
	2	HDD_LED_N	

## 2.4.4 BAT : Battery

The SPC-9000's real-time clock is powered by a lithium battery. It is equipped with Panasonic BR2032 190mAh lithium battery. It is recommended that you not replace the lithium battery on your own, but if the battery needs to be changed, please contact the Vecow RMA service team.

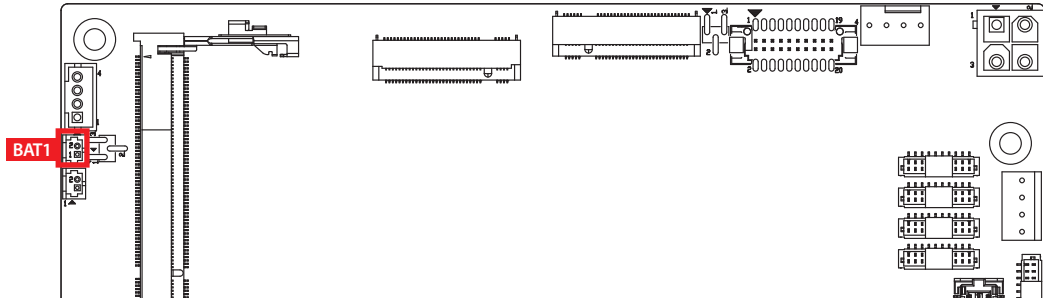

Pin No.	Function	
	1	+VRTC_BATT
2	GND	

## 2.4.5 AUDIO1 : Audio Connector

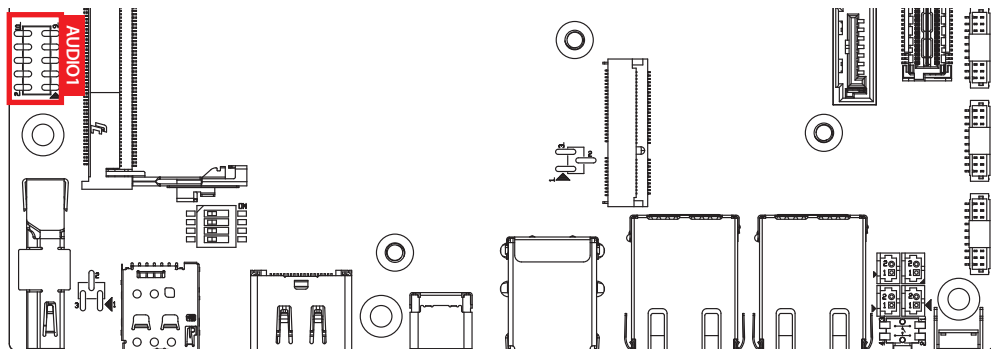

There are three audio connectors, mic-in, line-in, and line-out, in the top side of SPC-9000. Onboard Realtek ALC888 audio codec supports 7.1 channel HD audio and fully complies with Intel® High Definition Audio (Azalia) specifications.

To utilize the audio function in Windows platform, you need to install corresponding drivers for both Intel Broadwell-U chipset and Realtek ALC888 codec. Please refer to Chapter 4 for more details of driver installation.

The pinouts of Audio port are listed in the following table :

Pin No.	Definition		Pin No.	Definition
	1	A_z_MIC1-L		
3	A_z_MIC1-R	4	GND_EARTH	
5	A_z_LINEO-R	6	A_z_LINEI-R	
7	F_IO_SENSE	8	GND_EARTH	
9	A_z_LINEO-L	10	A_z_LINEI-L	



## 2.4.6 JUSB1 : Internal USB 2.0 Connector

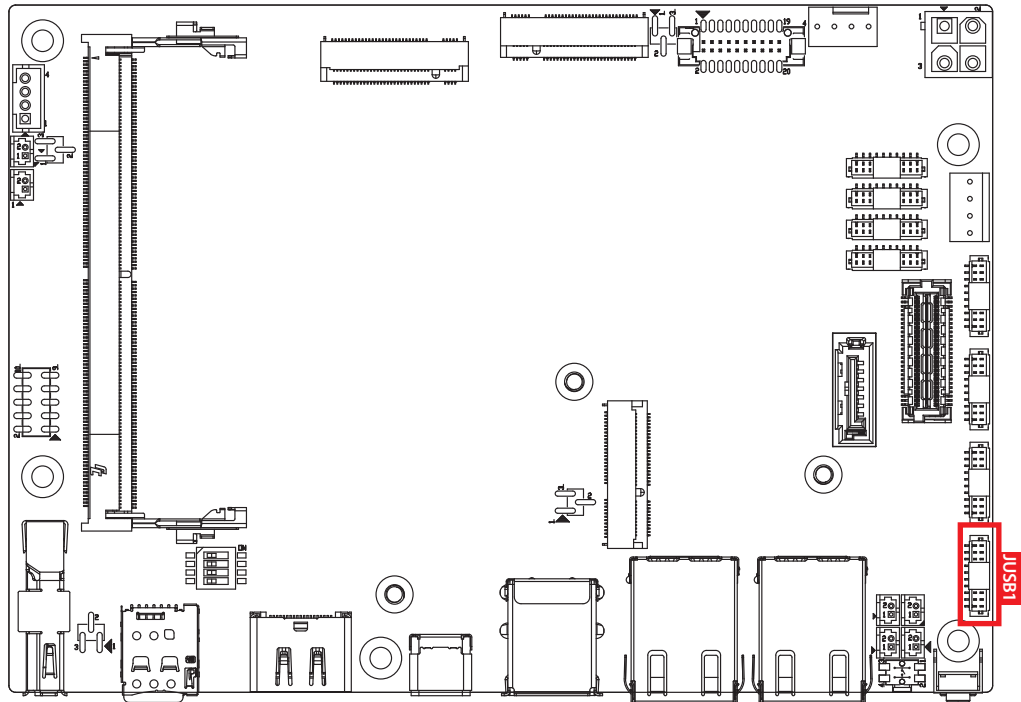

The SPC-9000 main board provides maxima four expansion USB ports. The USB interface supports 480 Mbps transfer rate which comply with high speed USB specification Rev. 2.0.

The USB interface is accessed through one 10-pin JST 1.0mm connector. You will need an adapter cable if you use a standard USB connector. The adapter cable has a 10-pin connector on one end and a USB connector on the other.

The pin assignments of JUSB1 and JUSB2 are listed in the following table :

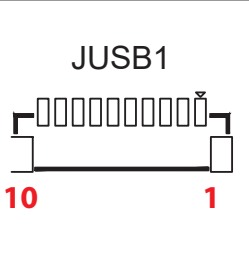
	Pin No.	Definition	Pin No.	Definition
	1	USB_VCC	2	USB_VCC
	3	USB_VCC	4	USB_D_4N
	5	USB_D_4P	6	USB_D_5N
	7	USB_D_5P	8	GND
	9	GND	10	GND

## 2.4.7 M2E\_CN1 : M.2 key E Slot for USB 2.0, PCIe Gen3x1 support

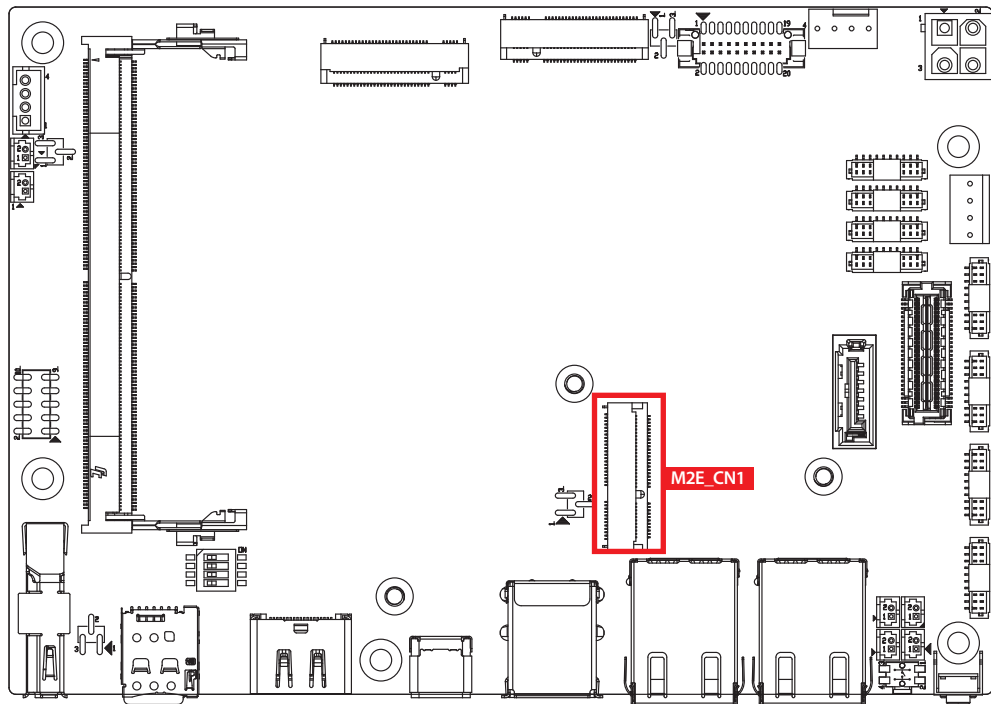

M.2 key E connector is suitable for applications that use wireless connectivity including Wi-Fi, Bluetooth, NFC or GNSS. Module card types include 2230.

The pin assignments of M2E\_CN1 are listed in the following table:

Pin No.	Signal Name	Pin No.	Signal Name
74	3.3V	75	GND
72	3.3V	73	RESERVED/REFCLKn1
70	NC	71	RESERVED/REFCLKp1
68	NC	69	GND
66	NC	67	RESERVED/PETn1
64	NC	65	RESERVED/PETp1
62	ALERT# (O)(0/3.3V)	63	GND
60	12C_CLK (I)(0/3.3V)	61	RESERVED/PERn1
58	12C_DATA (I/O)(0/3.3V)	59	RESERVED/PERp1
56	NC	57	GND
54	NC	55	PEWAKE0# (I/O)(0/3.3V)
52	PERST03# (I)(0/3.3V)	53	CLKREQ0# (I/O)(0/3.3V)

Pin No.	Signal Name	Pin No.	Signal Name
50	NC	51	GND
48	NC	49	REFCLKn0
46	NC	47	REFCLKp0
44	NC	45	GND
42	NC	43	PETn0
40	NC	41	PETp0
38	NC	39	GND
36	NC	37	PERn0
34	NC	35	PERp0
32	NC	33	GND
	Module Key		Module Key
	Module Key		Module Key
	Module Key		Module Key
	Module Key		Module Key
22	NC	23	NC
20	NC	21	NC
18	NC	19	NC
16	NC	17	NC
14	NC	15	NC
12	NC	13	NC
10	NC	11	NC
8	NC	9	NC
6	LED# (O)(od)	7	GND
4	3.3V	5	USB_D-
2	3.3V	3	USB_D+
		1	GND

## 2.4.8 M2B\_CN1 : M.2 key B Slot for PCIe Gen3x2 or USB3.2 Gen2 support (Option by BIOS setting)

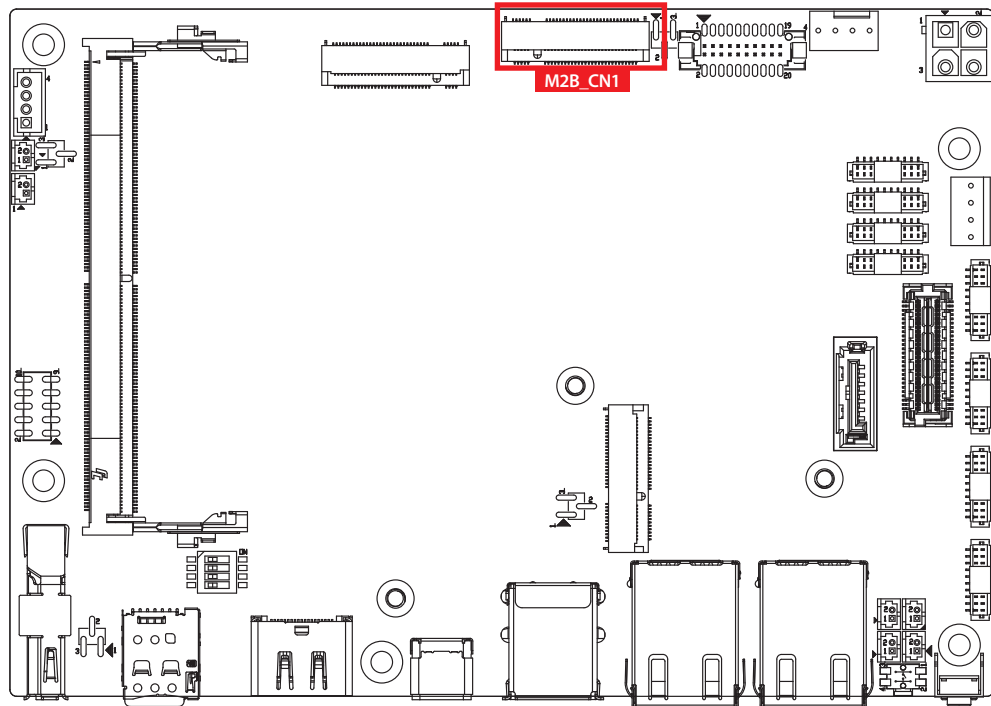

M.2 key B connector is suitable for applications that use wireless connectivity including LTE/5G module, and NVMe SSD (BW: PCIe x2) that types include 3042/3052.

The pin assignments of M2B\_CN1 are listed in the following table :

Pin No.	Signal Name	Pin No.	Signal Name
		80	Ground
75	NC		
73	Ground	74	3.3V
71	Ground	72	3.3V
69	CONFIG_1	70	3.3V
67	NC	68	NC
65	NC	66	SIM DETECT
63	NC	64	NC
61	NC	62	NC
59	NC	60	NC

Pin No.	Signal Name	Pin No.	Signal Name
57	Ground	58	NC
55	REFCLKp	56	NC
53	REFCLKn	54	PEWAKE#
51	Ground	52	CLKREQ#
49	PETp0	50	PERST#
47	PETn0	48	NC
45	Ground	46	NC
43	PERp0	44	NC
41	PERn0	42	NC
39	Ground	40	NC
37	PETp1/USB3.1-TX+	38	DEVSLP
35	PETp1/USB3.1-TX-	36	UIM-PWR
33	Ground	34	UIM-DATA
31	PETp1/USB3.1-RX+	32	UIM-CLK
29	PETp1/USB3.1-RX-	30	UIM-RESET
27	Ground	28	NC
25	NC	26	NC
23	NC	24	NC
21	NC	22	NC
		20	NC
Mechanical Key			
11	Ground		
9	USB-	10	LED_1#
7	USB+	8	W_DISABLE1
5	Ground	6	FULL_CARD_PWR_OFF/ON
3	Ground	4	3.3V
1	NC	2	3.3V

## 2.4.9 M2M\_CN1 : M.2 key M Slot for PCIE Gen4x4 / SATA

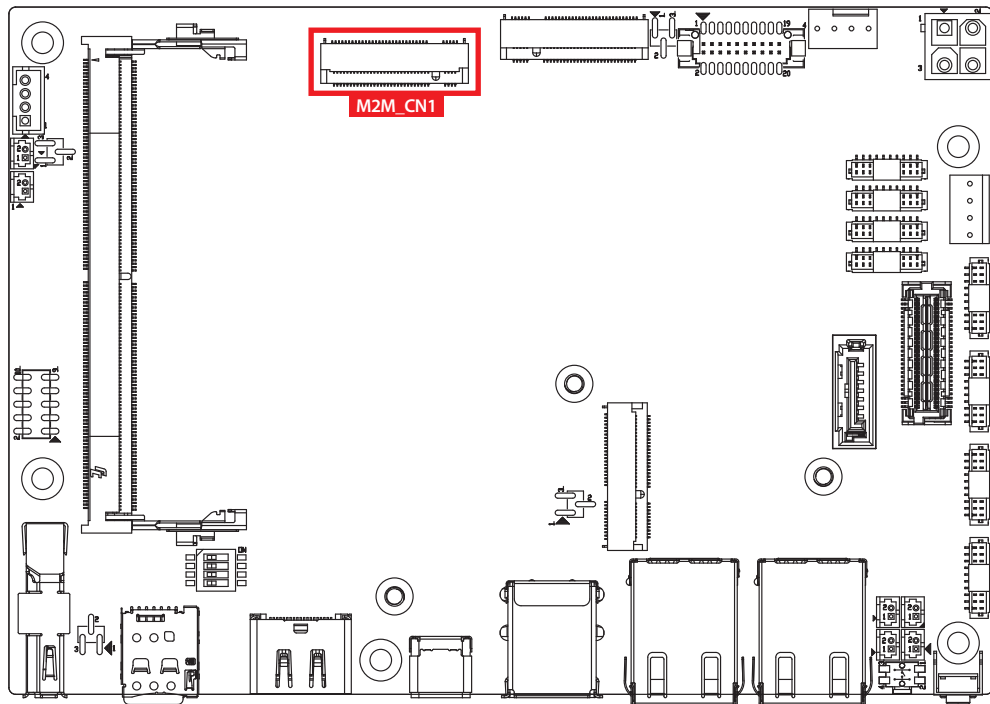

M.2 key M connector is suitable for applications that use Host I/Fs supported by either PCIe or SATA Module card types include 2280.

The pin assignments of M2M\_CN1 are listed in the following table:

Pin No.	Function	Pin No.	Function
75	Ground		
73	Ground	74	3.3V
71	Ground	72	3.3V
69	PEDET	70	3.3V
67	Ground	68	NC
Mechanical Key			
57	Ground	58	NC
55	REFCLKp	56	NC
53	REFCLKn	54	PEWAKE#
51	Ground	52	CLKREQ#
49	PETp0/SATA_A+	50	PERST#
47	PETn0/SATA_A-	48	NC

45	Ground	46	NC
43	PERp0/SATA_B-	44	NC
41	PERn0/SATA_B+	42	NC
39	Ground	40	NC
37	PETp1	38	DEVSLP
35	PETn1	36	NC
33	Ground	34	NC
31	PERp1	32	NC
29	PERn1	30	NC
27	Ground	28	NC
25	PETp2	26	NC
23	PETn2	24	NC
21	Ground	22	NC
19	PERp2	20	NC
17	PERn2	18	3.3V
15	Ground	16	3.3V
13	PETp3	14	3.3V
11	PETn3	12	3.3V
9	Ground	10	LED1#
7	PERp3	8	NC
5	PERn3	6	NC
3	Ground	4	3.3V
1	Ground	2	3.3V

## 2.4.10 JCOM1, JCOM2, JCOM3, JCOM4 : Serial Port

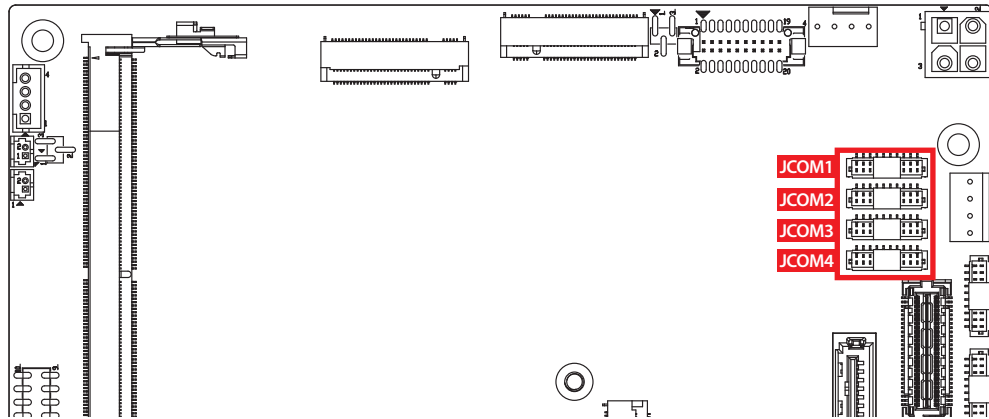

Serial port 1 to 4 (JCOM 1 to 4) can be configured for RS-232, RS-422, or RS-485 with auto flow control communication. The default definition of COM 1 to 4 is RS-232, if you want to change to RS-422 or RS-485, you can find the setting in BIOS.

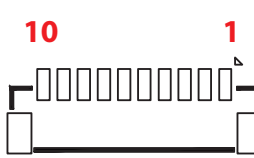
	BIOS Setting		Function	
	COM 1 (JCOM1) COM 2 (JCOM2) COM 3 (JCOM3) COM 4 (JCOM4)			RS-232
				RS-422 (5-wire)
				RS-485
			RS-485 w/z auto-flow control	

The pin assignments are listed in the following table :

Serial Port	Pin No.	RS-232	RS-422 (5-wire)	RS-485 (3-wire)
1, 2 3, 4	1	GND_EARTH	GND_EARTH	GND_EARTH
	2	GND	GND	GND
	3	RI	-----	RI
	4	DTR	RXD-	-----
	5	CTS	-----	-----
	6	TXD	RXD+	-----
	7	RTS	-----	-----
	8	RXD	TXD+	DATA+
	9	DSR	-----	-----
	10	DCD	TXD-	DATA-



## 2.4.11 eDP1 : eDP connector

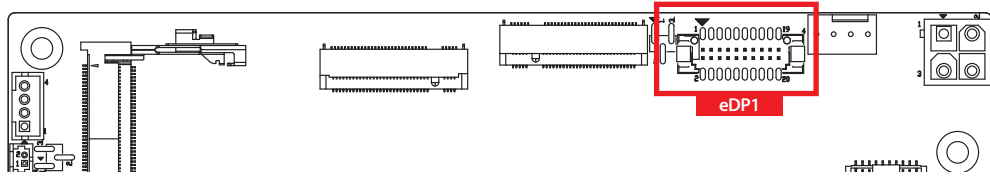

SPC-9000 supports eDP display and up to 3840 x 2400 pixels resolution.

The pin assignments of eDP are listed in the following table:

Pin No.	Definition	Pin No.	Definition
1	GND	2	EDP_VDD
3	EDP_PANEL_z_TX0-	4	EDP_VDD
5	EDP_PANEL_z_TX0+	6	EDP_BKLT_EN
7	GND	8	EDP_BKLT_CTRL
9	EDP_PANEL_z_TX0-	10	EDP_HPD_LS
11	EDP_PANEL_z_TX0+	12	EDP_VCCS
13	GND	14	EDP_VCCS
15	EDP_PANEL_z_AUX-	16	EDP_VCCS
17	EDP_PANEL_z_AUX+	18	GND
19	GND	20	GND

## 2.4.12 SATA1 : SATA III Connector

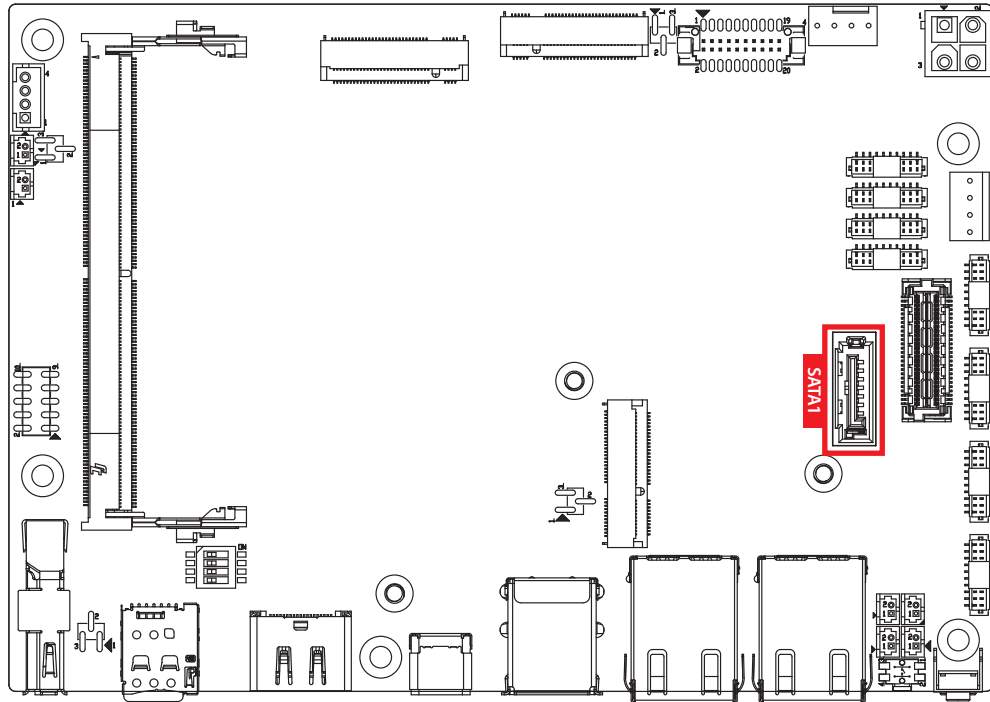

There is a high performance Serial ATA III (SATA III) on the SPC-9000. They support higher storage capacity with less cabling effort and smaller required space. The pin assignments of SATA1 are listed in the following table:

	Pin No.	Definition	Pin No.	Definition
	1	GND	2	TXP
	3	TXN	4	GND
	5	RXN	6	RXP
	7	GND		

## 2.4.13 HDD\_PWR1 : SATA Power Connector

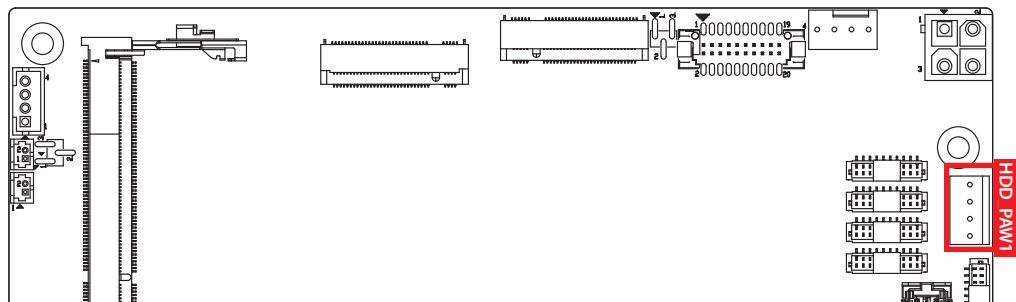

The SPC-9000 is also equipped with one SATA power connector. It supports 5V (Up to 2A) and 12V (Up to 2A) currents to the hard drive or SSD. The pin assignments of HDD\_PWR1 is listed in the following table:

Pin No.	Definition	Pin No.	Definition
1	+12V	2	GND
3	GND	4	+5V

## 2.4.14 SUMIT : SUMIT B Connector

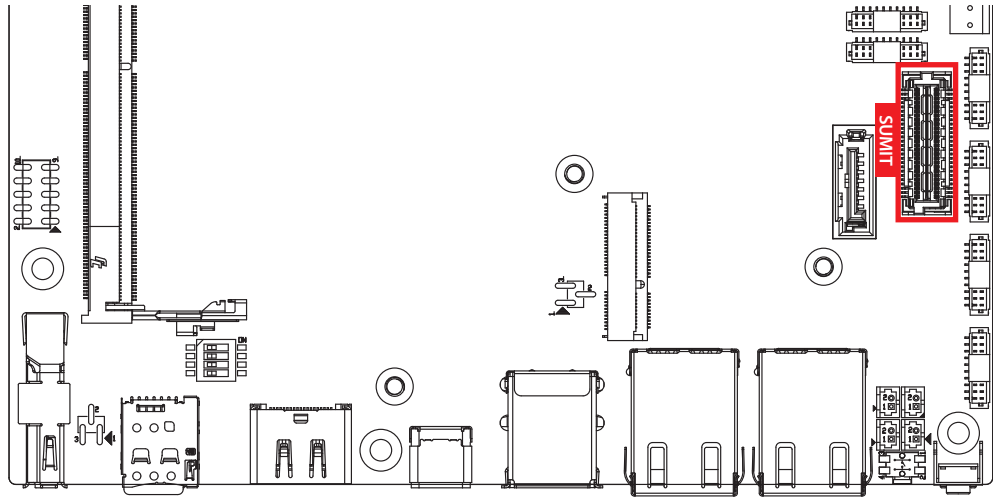

SUMIT-B Connector Pin Out :

Pin No.	Definition	Pin No.	Definition
1	GND	2	GND
3	B_PET_P0	4	B_PER_P0
5	B_PET_N0	6	B_PER_N0
7	GND	8	GND
9	C_CLKP	10	B_CLKP
11	C_CLKN	12	B_CLKN
13	CPRSNT#/C_PE_CLKREQ#	14	GND
15	C_PET_P0	16	C_PER_P0
17	C_PET_N0	18	C_PER_N0
19	GND	20	GND
21	C_PET_P1	22	C_PER_P1
23	C_PET_N1	24	C_PER_N1
25	GND	26	GND
27	C_PET_P2	28	C_PER_P2
29	C_PET_N2	30	C_PER_N2
31	GND	32	GND
33	C_PET_P3	34	C_PER_P3
35	C_PET_N3	36	C_PER_N3
37	GND	38	GND
39	PERST#	40	WAKE#
41	Reserves	42	Reserves
43	+5V	44	Reserves
45	+5V	46	+3.3V
47	+5V	48	+3.3V
49	+5V	50	+3.3V
51	+5V	52	+5V_AUX

## 2.4.15 SYS\_FAN1

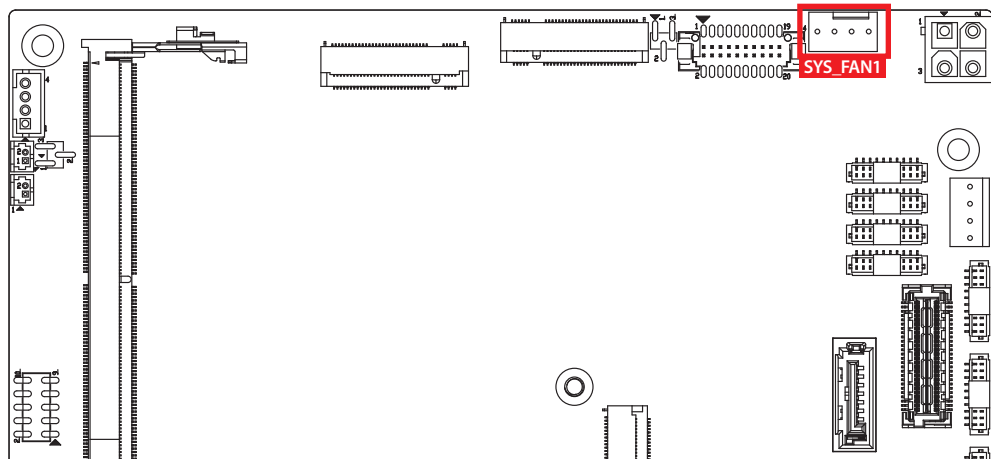

Fan power connector supports higher thermal requirements

	Pin No.	Definition	Pin No.	Definition
	1	GND	2	+12V (2.0A max)
3	Fan speed sensor	4	Fan PWM	

## 2.4.16 JDIO1, JDIO2 : GPIO from Super I/O

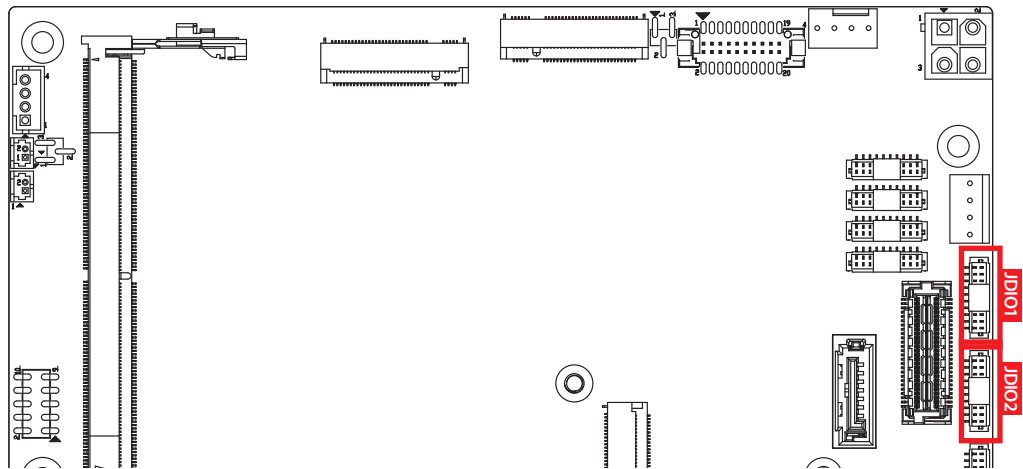

There is a 16-bit GPIO connector in the Top side. Each GPIO channel can be configuration GPI or GPO. JSEL\_DIO header is for SYNC/SOURCE mode selection on ISO\_DIO board (DMX-100-E)

JDIO1 and JDIO2 pins are defined in the following table:

	Pin No.	JDIO1 Definition	JDIO2 Definition
	1	SIO_GPI80	SIO_GPO70
	2	SIO_GPI81	SIO_GPO71
	3	SIO_GPI82	SIO_GPO72
	4	SIO_GPI83	SIO_GPO73
	5	SIO_GPI84	SIO_GPO74
	6	SIO_GPI85	SIO_GPO75
	7	SIO_GPI86	SIO_GPO76
	8	SIO_GPI87	SIO_GPO77
	9	+3.3V	+3.3V
10	GND	GND	

## 2.4.17 RST\_SW1 : RESET Button

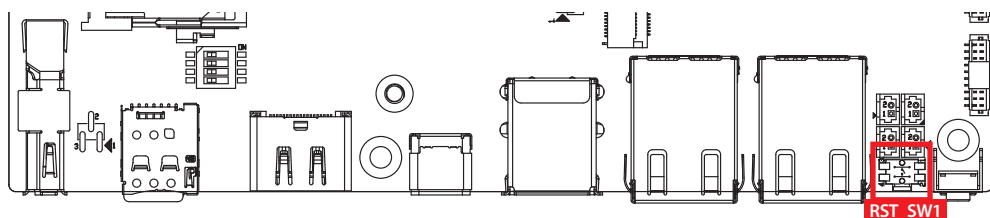

Pin assignment as the following table :

	Pin No.	Definition	Pin No.	Definition
	1	FP_RST_BTN_N	2	GND
	3	FP_RST_BTN_N	4	GND

## 2.4.18 JIGN1 : IGNITION Control and Remote Power on switch

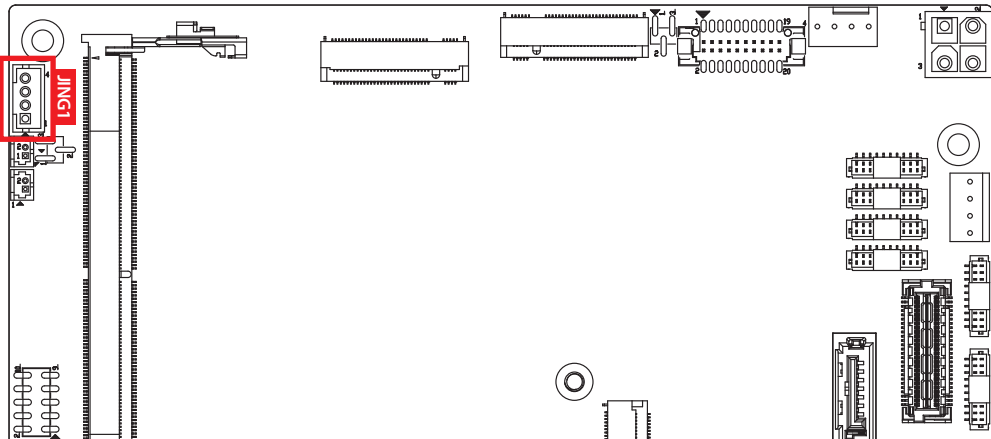

Pin assignment as the following table :

	Pin No.	Definition	Pin No.	Definition
	1	FP_PWR_BTN_P	2	GND
3	IGNITION	4	GND	

## 2.4.19 M2B\_SIM1 : Nano SIM Card Socket for M.2 key B Slot

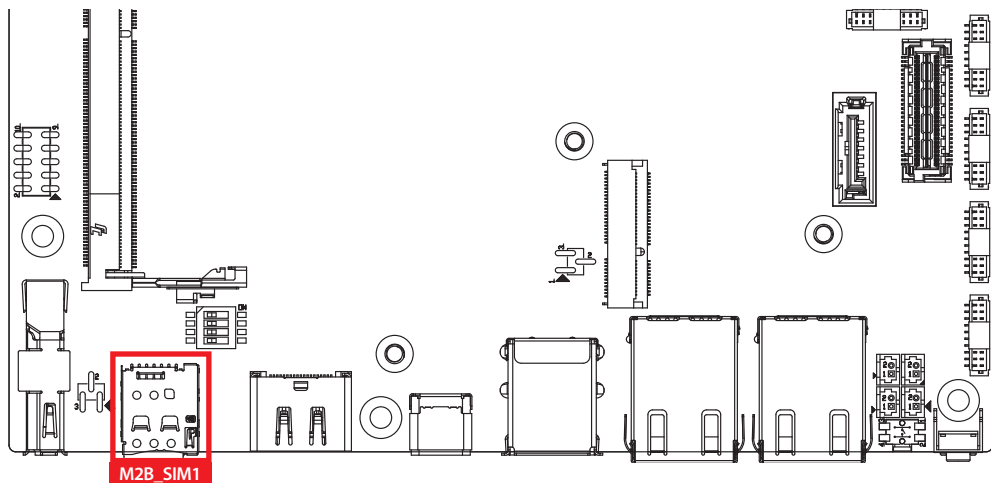

The Nano SIM card socket is support Push-Push type. Please make sure to unplug the system power before inserting the Nano SIM card.

## 2.5 Main Board Jumper Settings

### 2.5.1 TOP View of SPC-9000/9100/9200 Main Board with Jumper Location

The figure below is the top view of the SPC-9000 main board. It shows the location of the jumpers.

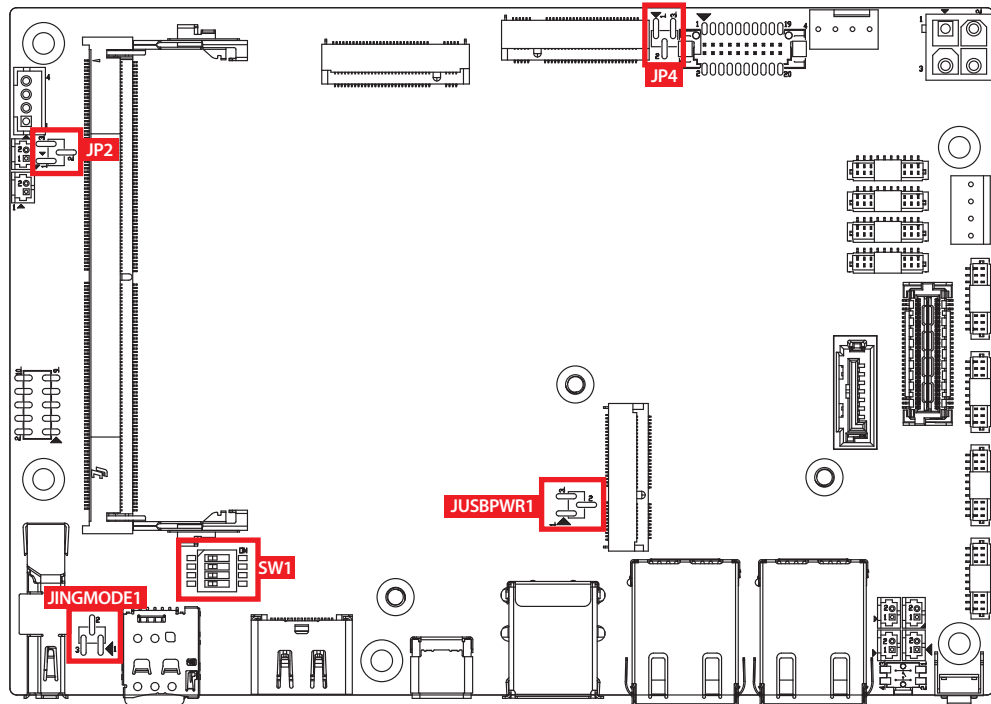

You may configure your card to match the needs of your application by setting jumpers. A jumper is a metal bridge used to close an electric circuit. It consists of two metal pins and a small metal clip (often protected by a plastic cover) that slides over the pins to connect them. To "close" a jumper, you connect the pins with the clip. To "open" a jumper, you remove the clip. Sometimes a jumper will have three pins, labeled 1, 2, and 3. In this case you would connect either pins 1 and 2, or 2 and 3.

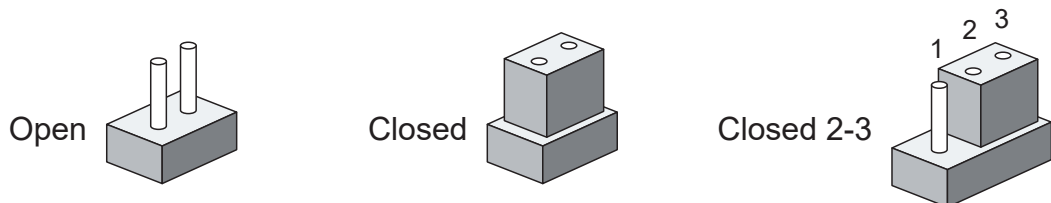

## 2.5.2 JP4: Power Selection for eDP Module

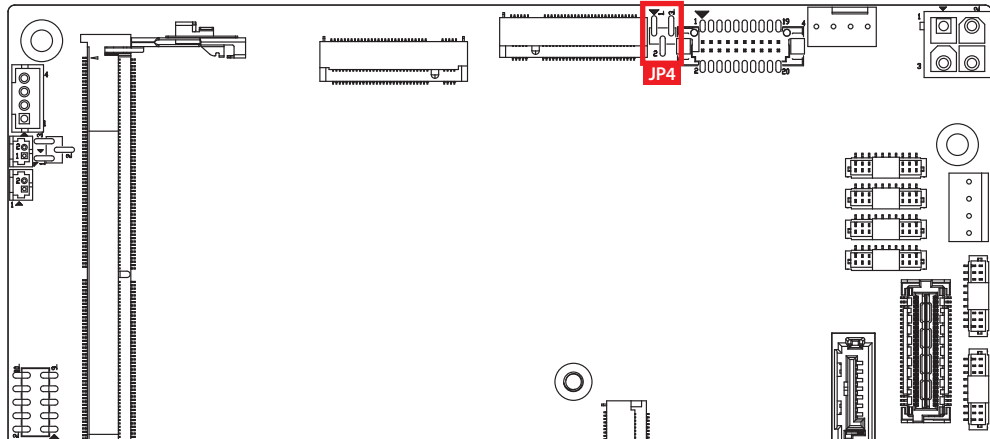

JP4 provides eDP voltage selection function, Closing Pin 1 and Pin 2 is for 3.3V eDP power input; closing Pin 2 and Pin 3 is for 5V eDP power input.

	Pin No.	Definition
		1-2
	2-3	+5V

## 2.5.3 JP2 : Clear CMOS

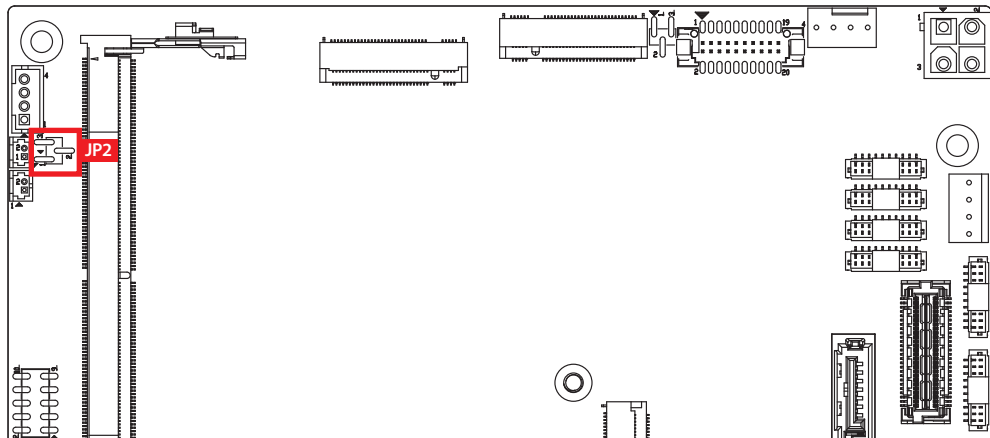

	Pin No.	Definition
		1-2
	2-3	Clear CMOS



## 2.5.4 JUSBPWR1 : Power Selection for EXT and INT USB 3.2 Gen2 / USB 2.0 Ports

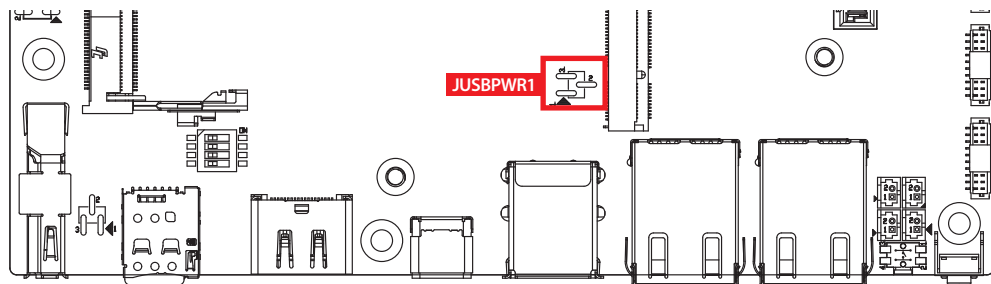

		Pin No.	Definition
1		1-2	+5V Standby Power
		2-3	+5V System Power

## 2.5.5 JIGNMODE1 : IGN Mode

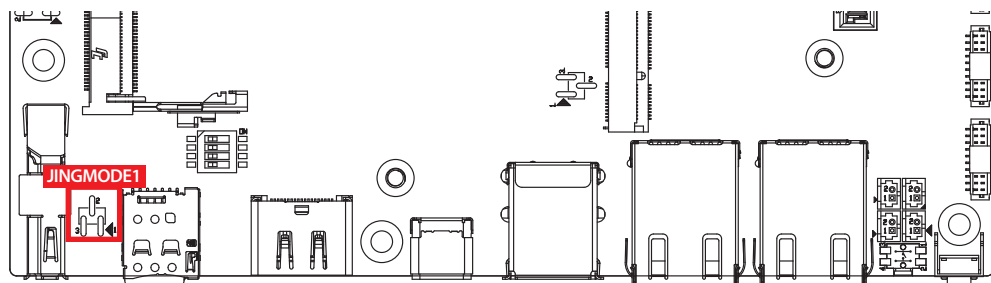

		Pin No.	Definition
1		1-2	H/W mode
		2-3	S/W mode (Default)

## 2.6 Ignition Control





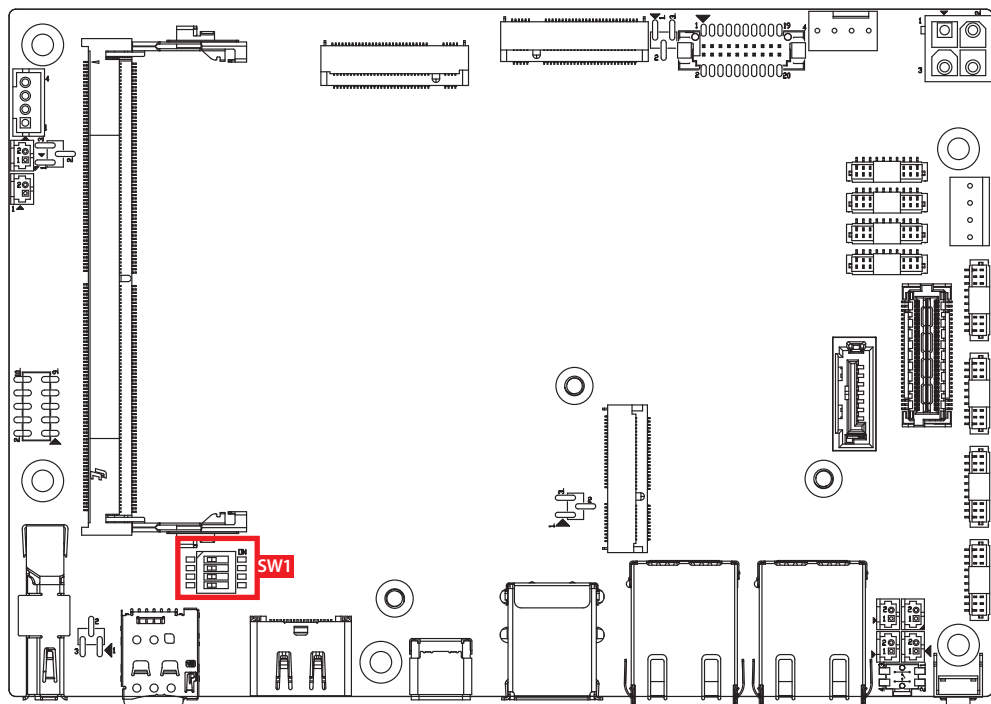

SPC-9000 series series provides ignition power control feature for in-vehicle applications. The built-in MCU monitors the ignition signal and turns on/off the system according to pre-defined on/off delay period.

### 2.6.1 Adjust Ignition Control Modes

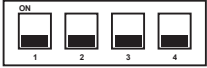
SPC-9000 series series provides 16 modes of different power on/off delay periods adjustable via SW1 switch. The default rotary switch is set to 0 in ATX/AT power mode.

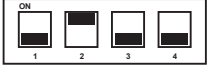
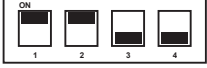
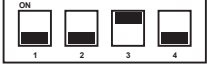
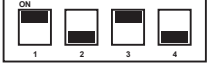
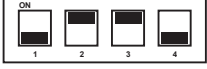
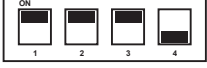
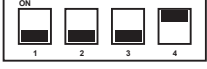
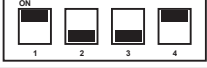
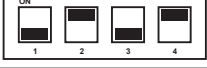

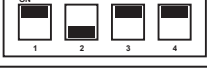
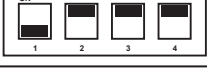
The modes are listed in the following table :

DIP Switch Position	Power on delay	Power off delay	Switch Position
0	ATX/AT mode (Default)		
1	No delay	No delay	
2	No delay	5 seconds	
3	No delay	10 seconds	
4	No delay	20 seconds	
5	5 seconds	30 seconds	
6	5 seconds	60 seconds	
7	5 seconds	90 seconds	
8	5 seconds	30 minutes	
9	5 seconds	1 hour	
A	10 seconds	2 hours	
B	10 seconds	4 hours	
C	10 seconds	6 hours	
D	10 seconds	8 hours	
E	10 seconds	12 hours	
F	10 seconds	24 hours	

## 2.6.2 Ignition Control Wiring

To activate ignition control, you need to provide IGN signal via the 3-pin pluggable terminal block locates in the back panel. Please find below the general wiring configuration

Pin No.	Definition
1	Ignition (IGN)
2	SW+
3	SW-



For testing purpose, you can refer to the picture blow to simulate ignition signal input controlled by a latching switch.

Note :

1. DC power source and IGN share the same ground.
2. SPC-9000 series supports 9V to 55V wide range DC power input in ATX/AT mode. In Ignition mode, the input voltage is fixed to 12V/24V for car battery scenario.
3. For proper ignition control, the power button setting should be "Power Down" mode.

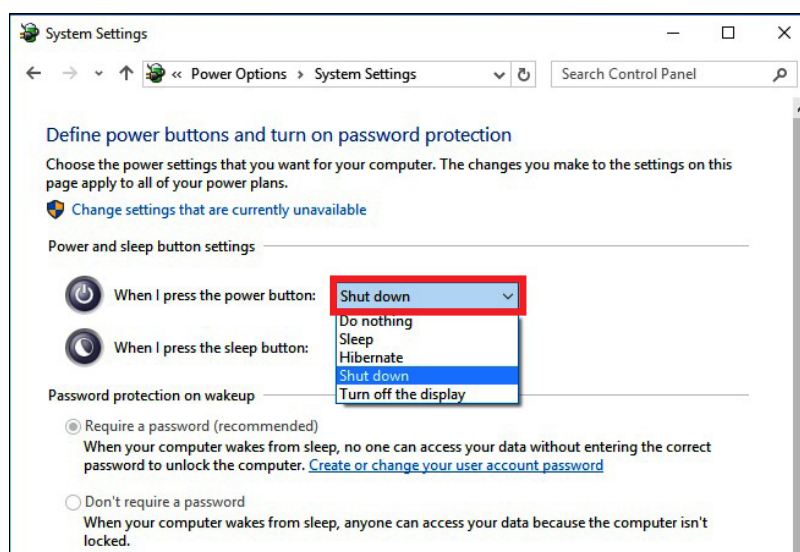

In Windows for example, you need to set "When I press the power button" to Shut down.

# 3

## SYSTEM SETUP

### 3.1 How to Open Your SPC-9000

#### 3.1.1 SPC-9000/9100/9200

**Step 1** Remove six F-M3x4L screws and open bottom cover.

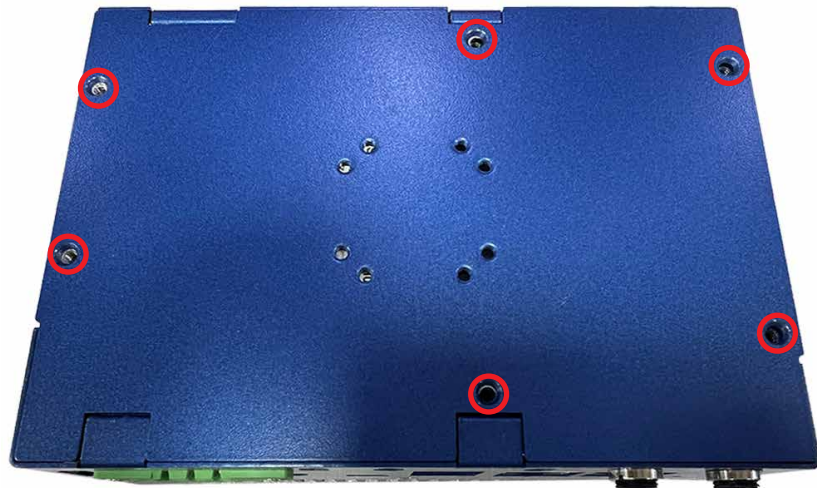

**Step 2** Remove two F-M3x4L screws and pick up SSD/HDD bracket.





**Step 3** Remove two PH-M3 screws and pick up spreader DDR.  
(circled in red M3x4L, circled in blue M3x6L)



**Step 4** Finished.

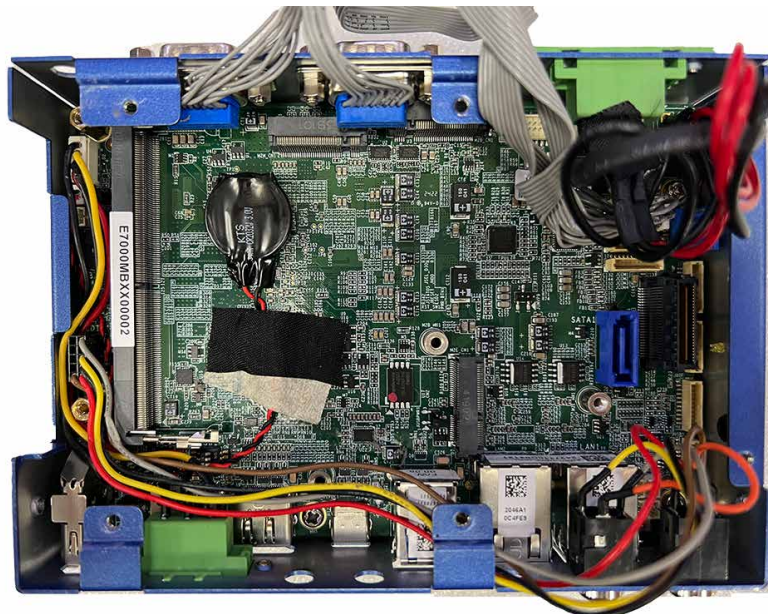

## 3.2 Installing DDR5 SO-DIMM Module

**Step 1** Find DDR5 SO-DIMM socket.

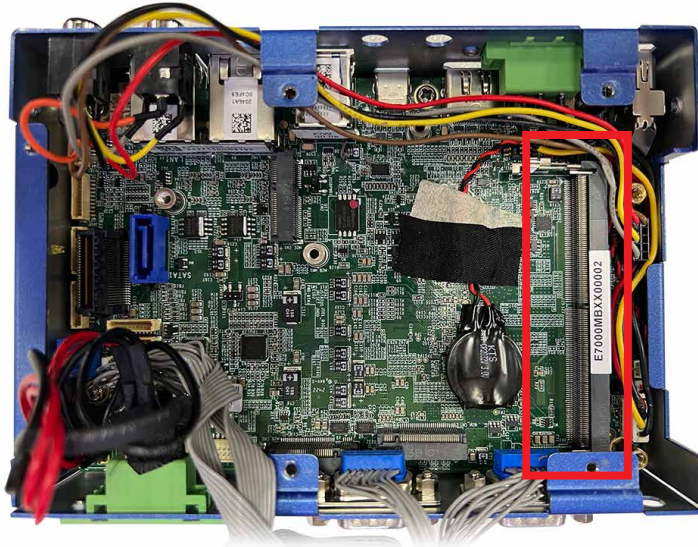

**Step 2** Install DDR5 RAM module into SO-DIMM slot.



**Step 3** Make sure the RAM module is locked by the memory slot.





### 3.3 Installing SIM Card

**Step 1** Remove one F-M3x4L screw and pick up SIM card cover.

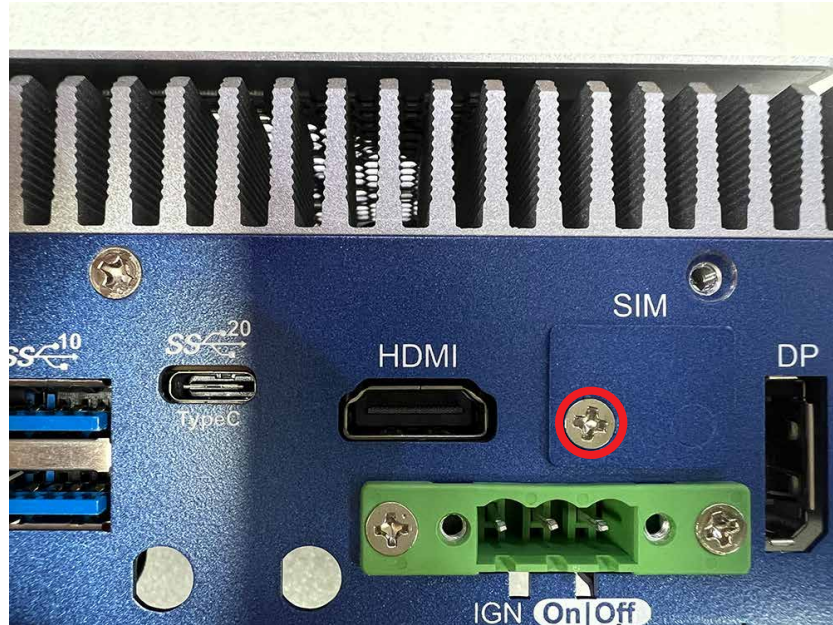

**Step 2** Install SIM card into to slot.

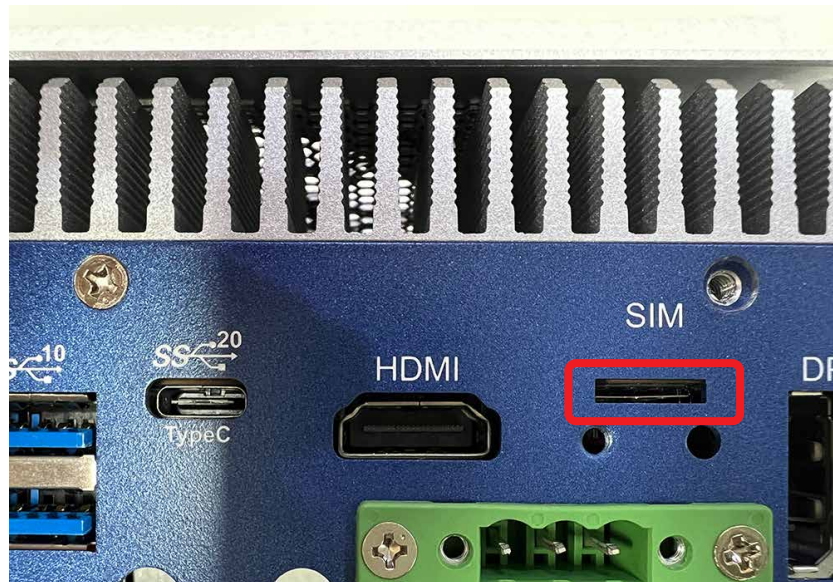



## 3.4 Installing M.2

Key E 2230(red), Key M 2280(blue), Key B 3052(orange)

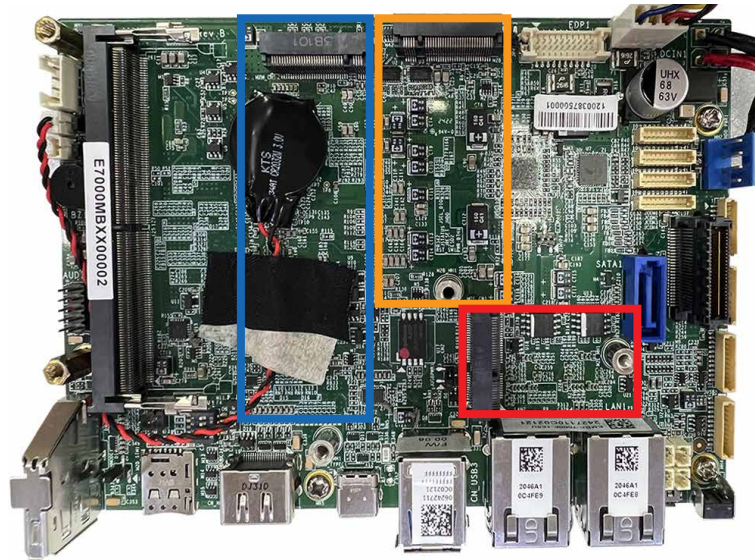

**Step 1** Install M.2 into the M.2 slot.



**Step 2** Fasten one PH-M3x6L screw.



### 3.5 Installing SSD/HDD

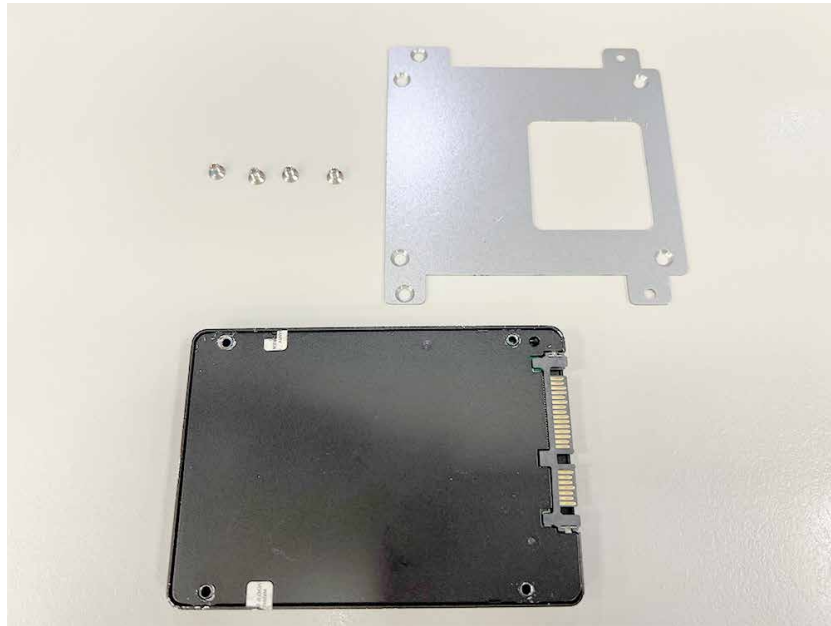

**Step 1** Fasten four F-M3x4L screws.

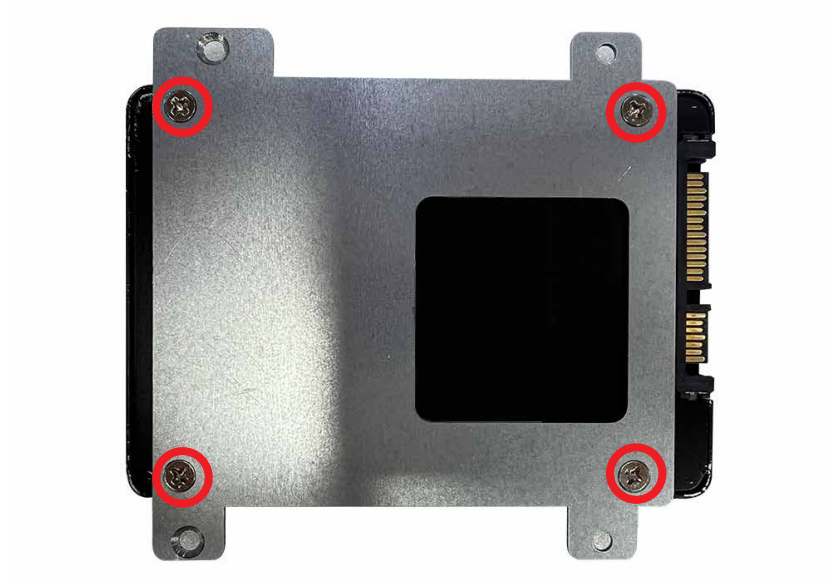

## 3.6 Installing Antenna Cable

**Step 1** Check antenna cable and washers.



**Step 2** Install antenna cable and then fasten washer and nut.



## 3.7 Mounting Your SPC-9000

### 3.7.1 SPC-9000

Fasten four F-M3x4L screws. (53-M006350-010)

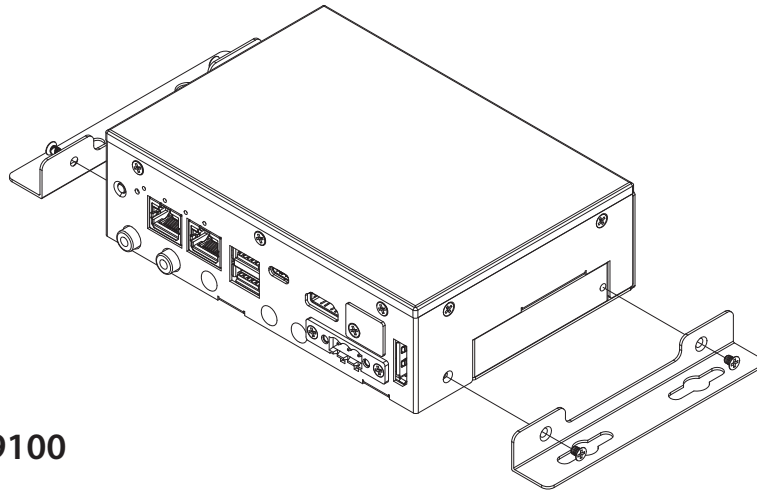

### 3.7.2 SPC-9100

Fasten four F-M3x4 screws. (53-M006350-010)

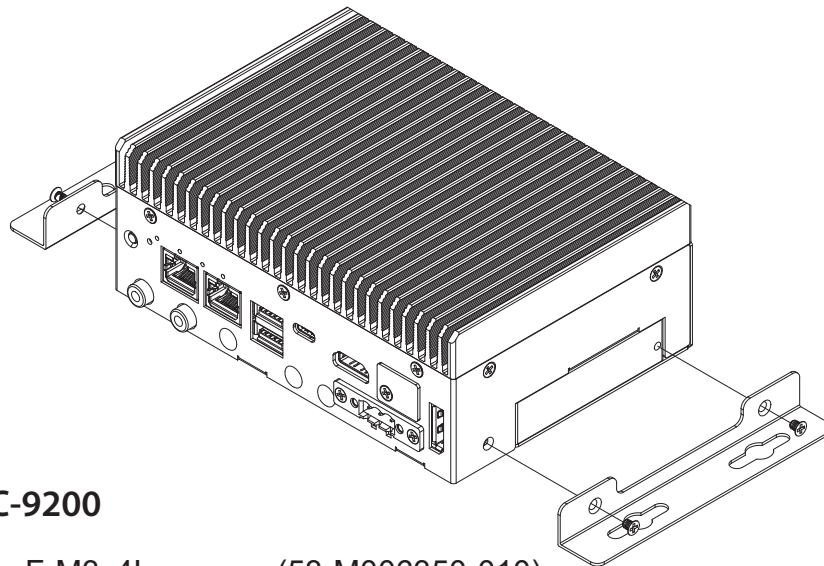

### 3.7.3 SPC-9200

Fasten four F-M3x4L screws. (53-M006350-010)

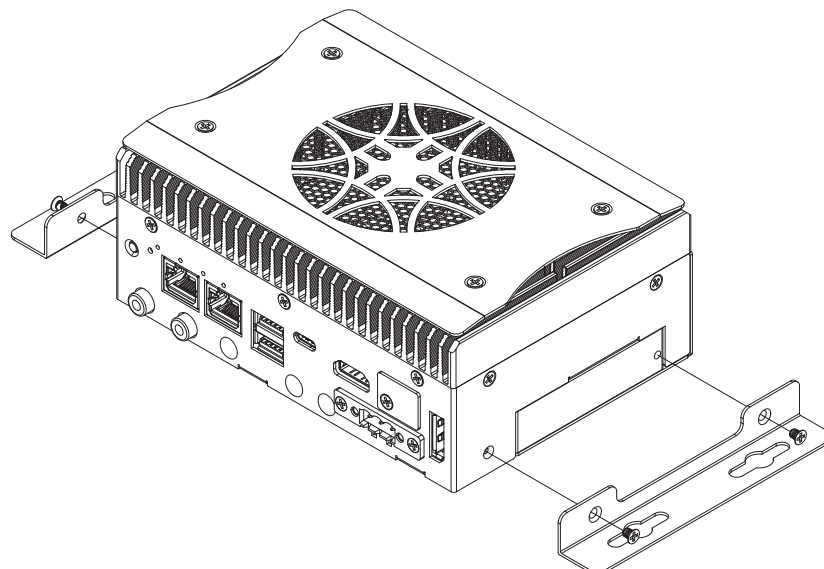

# 4

## BIOS SETUP

### 4.1 BIOS Setting

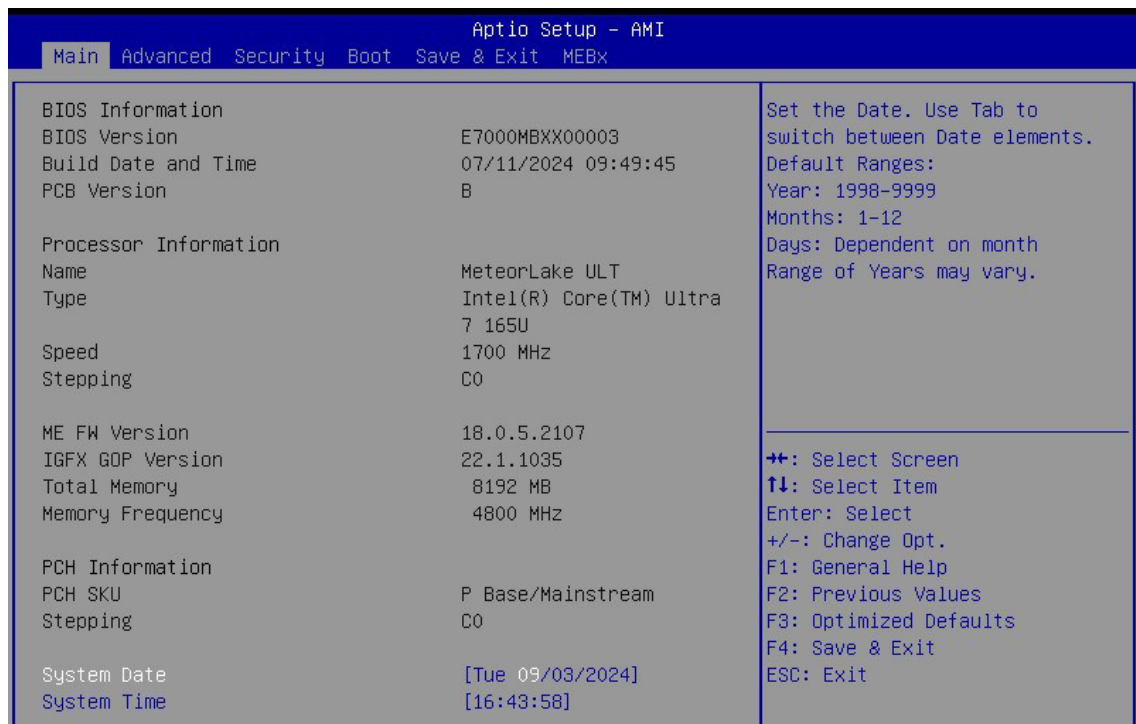

Figure 4-1 : Entering Setup Screen

BIOS provides an interface for users to check and change system configuration. The BIOS setup program is accessed by pressing the <Del> key when POST display output is shown.



## 4.2 Main Menu

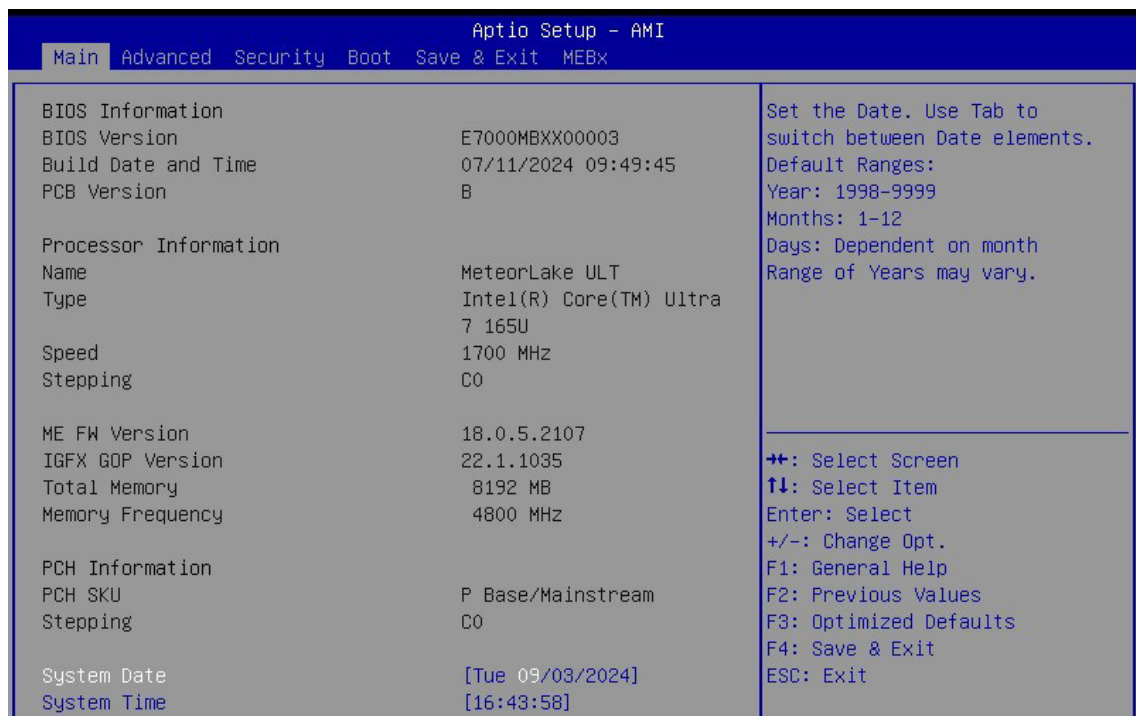

Figure 4-2 : Main Menu

The main menu displays BIOS version and system information. There are two options on Main menu.

### System Date

Set the Date. Use Tab to switch between Date elements.

Default Ranges: Year: 1998-9999

Months: 1-12

Days: Dependent on month

Range of Years may vary.

### System Time

Set the Time. Use Tab to switch between Time elements.

## 4.3 Advanced Menu

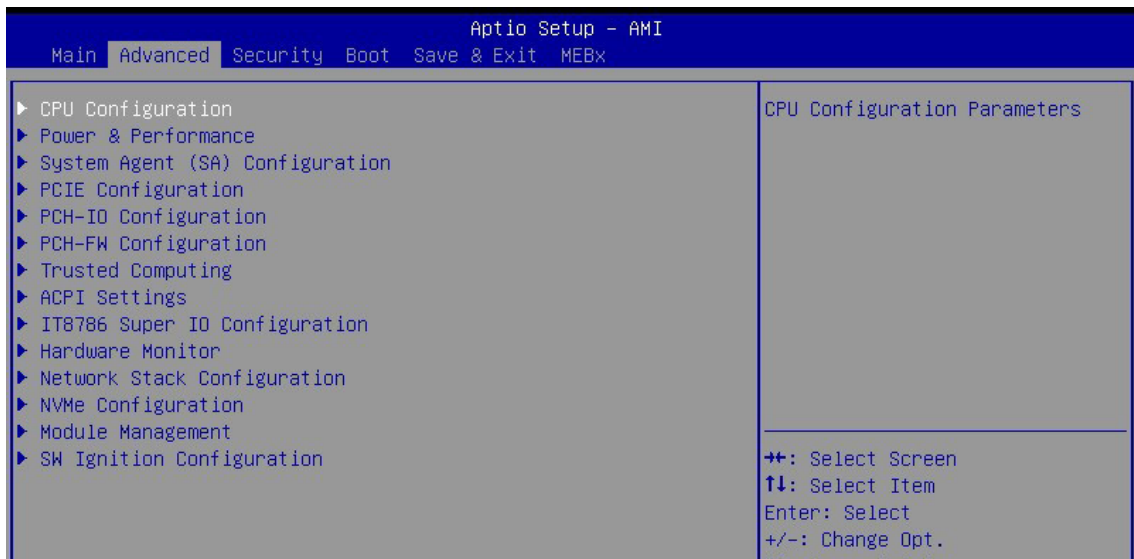

Figure 4-3 : BIOS Advanced Menu

Select advanced tab to enter advanced BIOS setup options such as CPU configuration, ACPI settings, and Super IO configuration.

### 4.3.1 CPU Configuration

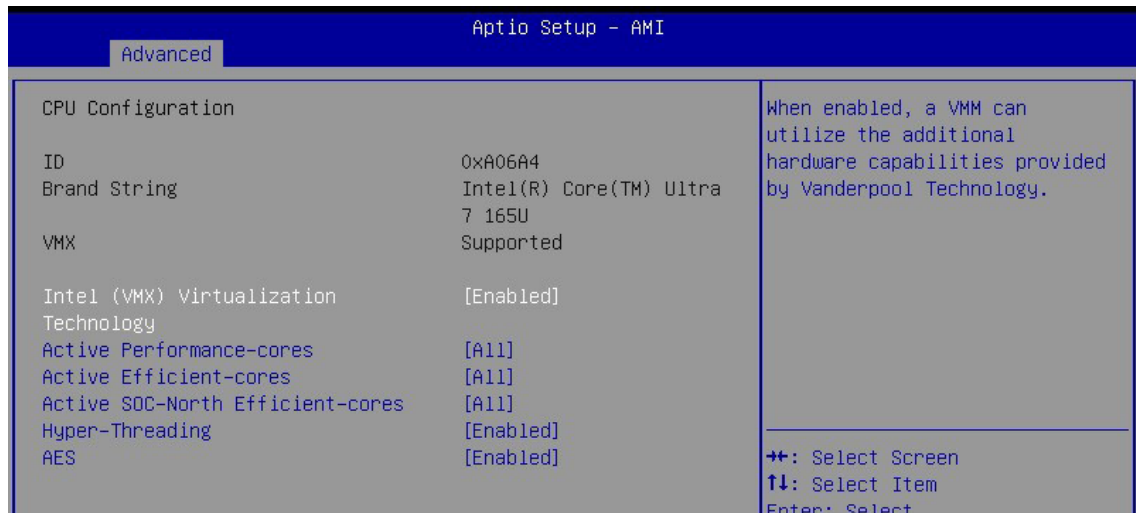

Figure 4-3-1 : CPU Configuration

#### Intel (VMX) Virtualization Technology

When enabled, a VMM can utilize the additional hardware capabilities provided by Vanderpool Technology.

#### Active Performance-cores

Number of P-cores to enable in each processor package. Note: Number of Cores and E-Cores are looked at together. When both are {0,0}, Pcode will enable all cores.

#### Active Efficient-cores

Number of E-cores to enable in each processor package. Note: Number of Cores and E-Cores are looked at together. When both are {0,0}, Pcode will enable all cores.

#### Active SOC-North Efficient-cores

Number of SOC-North Efficient-cores to enable in SOC North.

#### Hyper-Threading

Enable or Disable Hyper-Threading Technology.

#### AES

Enable/disable AES (Advanced Encryption Standard).



## 4.3.2 CPU - Power Management Control



Figure 4-3-2 : CPU - Power Management Control

### Turbo Mode

Enable/Disable processor Turbo Mode.

### View/Configure Turbo Options

View/Configure Turbo Options.

## 4.3.3 Memory Configuration

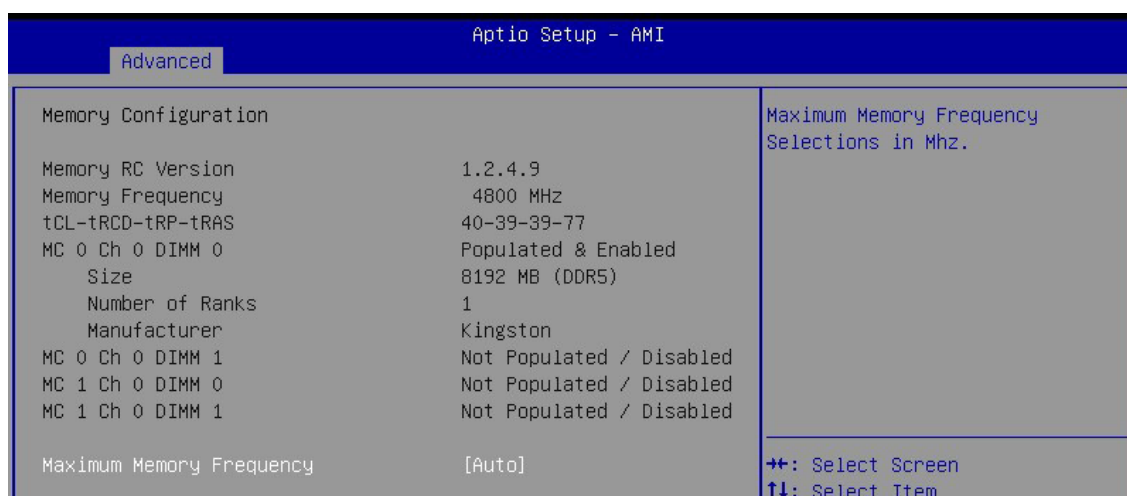

Figure 4-3-3 : Memory Configuration

### Maximum Memory Frequency

Maximum Memory Frequency Selections in Mhz.

### 4.3.4 Graphics Configuration

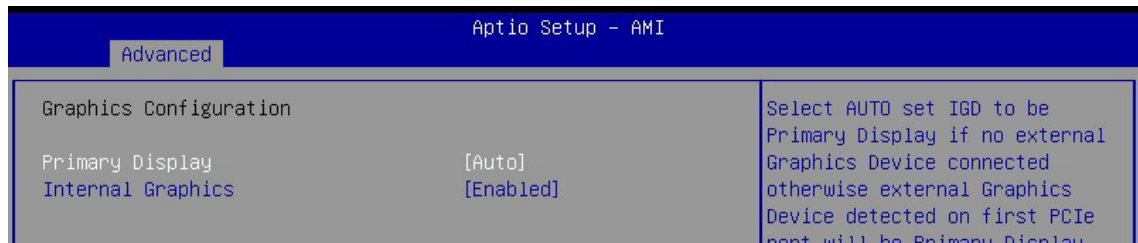

Figure 4-3-4 : Graphics Configuration

#### Primary Display

Select AUTO set IGD to be Primary Display if no external Graphics Device connected otherwise external Graphics Device detected on first PCIe port will be Primary Display or Select IGFX for IGD to be Primary Display Or Select HG for Hybrid Gfx.

#### Internal Graphics

Keep IGFX enabled based on the setup options.

### 4.3.5 VMD Configuration



Figure 4-3-5 : VMD Configuration

#### Enable VMD controller

Enable/Disable to VMD controller.

### 4.3.6 PCI Express Configuration (X)



Figure 4-3-6 : PCI Express Configuration

#### PCI Express Root Port (X)

Control the PCI Express Root Port.

#### PCIe Speed

Configure PCIe Speed.

### 4.3.7 PCH-IO Configuration

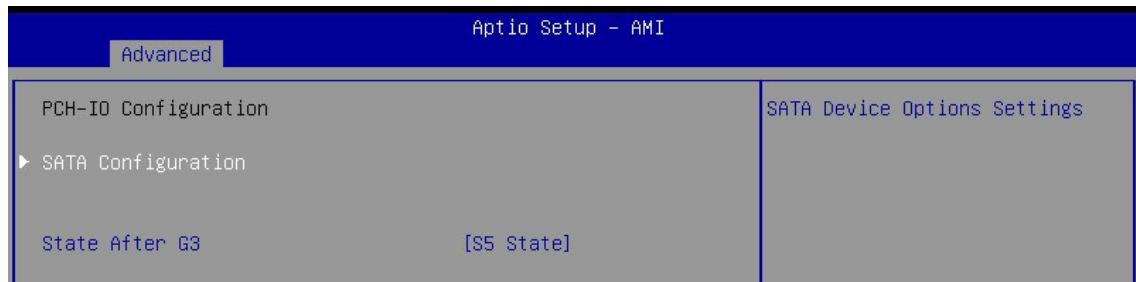

Figure 4-3-7 : PCH-IO Configuration

#### State After G3

Specify what state to go to when power is re-applied after a power failure (G3 state).

### 4.3.8 SATA Configuration



Figure 4-3-8 : SATA Configuration

#### SATA Controller(s)

Enable/Disable SATA Device.

#### Port (X)

Enable or Disable SATA Port.

### 4.3.9 PCH-FW Configuration

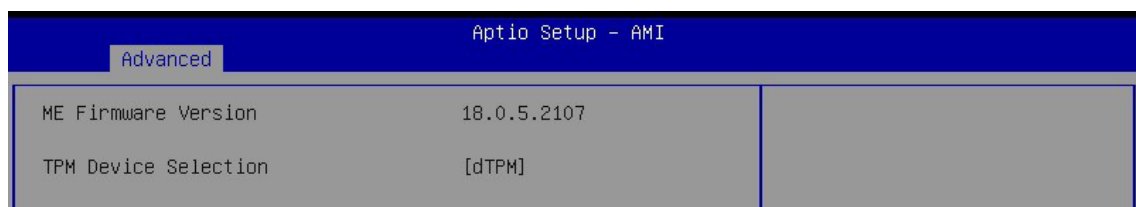

Figure 4-3-9 : PCH-FW Configuration

#### TPM Device Selection

Selects TPM device: PTT or dTPM. PTT - Enables PTT in SkuMgr dTPM 1.2 - Disables PTT in SkuMgr Warning ! PTT/dTPM will be disabled and all data saved on it will be lost.

### 4.3.10 Trusted Computing

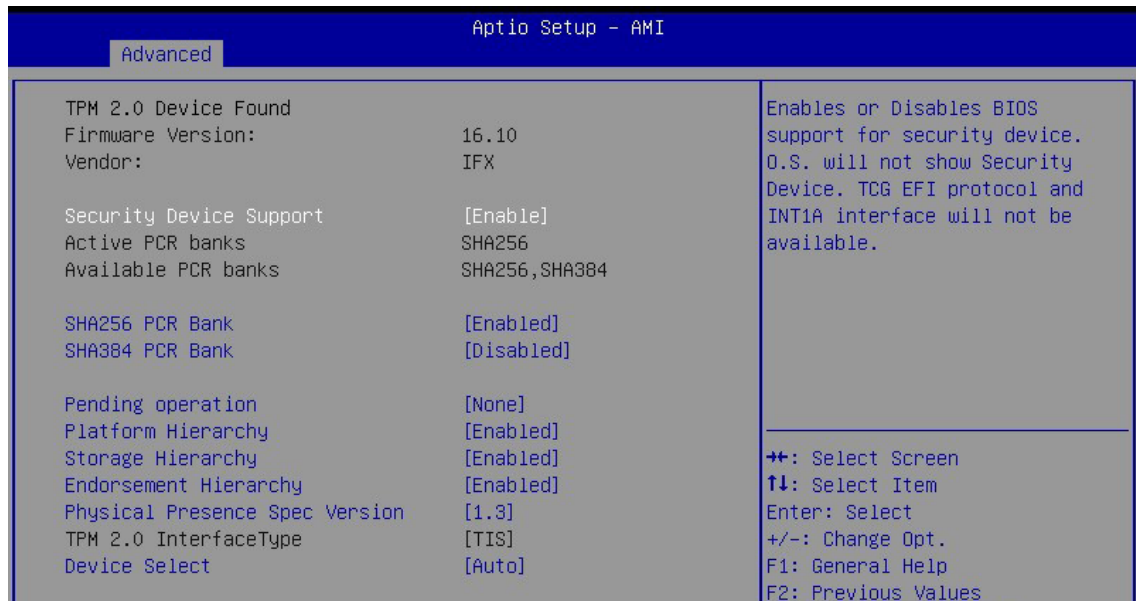

Figure 4-3-10 : Trusted Computing

Control the TPM device status and display related information if TPM chip is present.

### 4.3.11 ACPI Settings



Figure 4-3-11 : ACPI Settings

#### Enable Hibernation

Enables or Disables System ability to Hibernate (OS/S4 Sleep State). This option may not be effective with some operating systems.

#### ACPI Sleep State

Select the highest ACPI sleep state the system will enter when the SUSPEND button is pressed.

## 4.3.12 Serial Port(x) Configuration

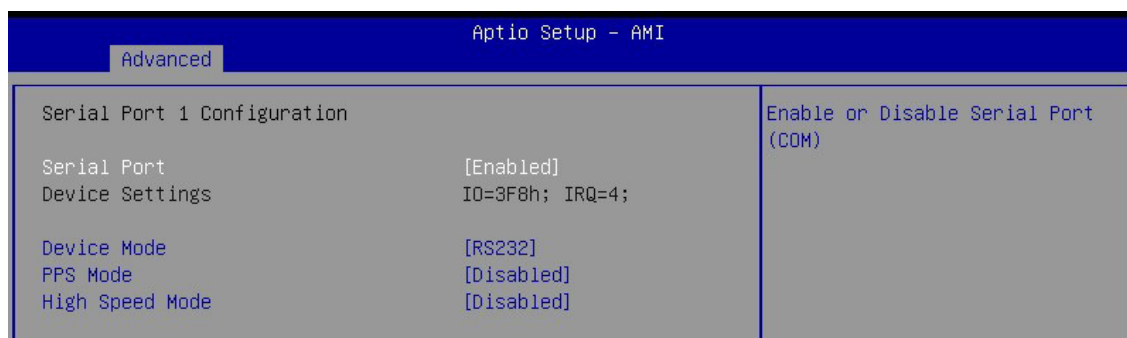

Figure 4-3-12 : Serial Port Configuration

### Serial Port

Enable or Disable Serial Port (COM).

### Device Mode

Select Device Mode.

### PPS Mode

Enable or Disable PPS.

### High Speed Mode (Only Serial Port 1)

Enable or Disable Serial Port High Speed.

## 4.3.13 Hardware Monitor

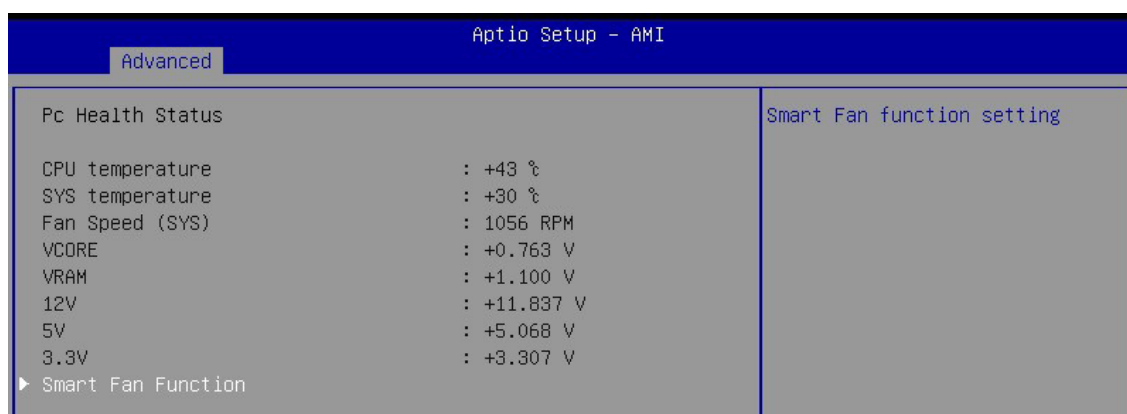

Figure 4-3-13 : Hardware Monitor

### Smart Fan Function

Smart Fan function setting.

### 4.3.14 Network Stack Configuration

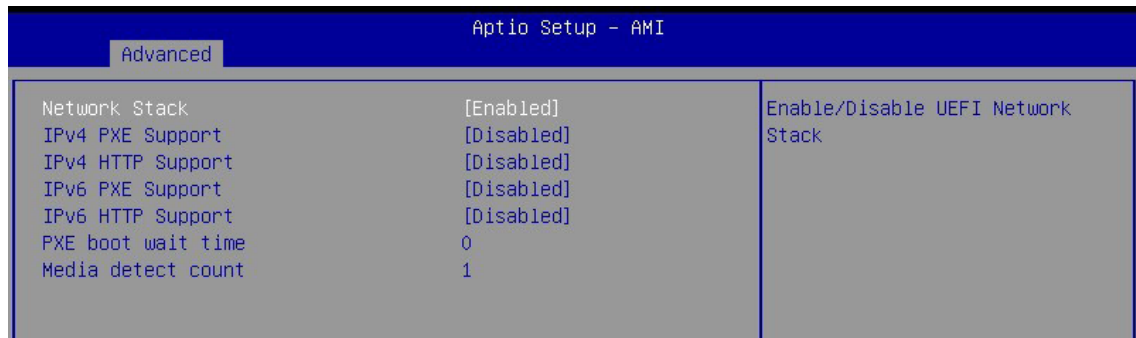

Figure 4-3-14 : Network Stack Configuration

#### Network Stack

Enable/Disable UEFI Network Stack.

#### IPv4 PXE Support

Enable/Disable IPv4 PXE boot support. If disabled, IPv4 PXE boot support will not be available.

#### IPv4 HTTP Support

Enable/Disable IPv4 HTTP boot support. If disabled, IPv4 HTTP boot support will not be available.

#### IPv6 PXE Support

Enable/Disable IPv6 PXE boot support. If disabled, IPv6 PXE boot support will not be available.

#### IPv6 HTTP Support

Enable/Disable IPv6 HTTP boot support. If disabled, IPv6 HTTP boot support will not be available.

#### PXE boot wait time

Wait time in seconds to press ESC key to abort the PXE boot. Use either +/- or numeric keys to set the value.

#### Media detect count

Number of times the presence of media will be checked. Use either +/- or numeric keys to set the value.

### 4.3.15 NVMe Configuration

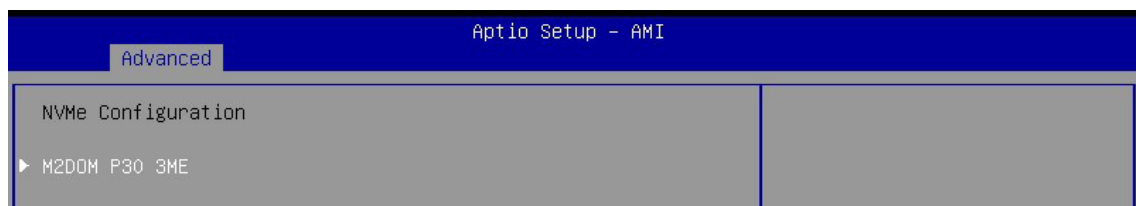

Figure 4-3-15 : NVMe Configuration

Display NVMe controller and Drive information.

## 4.3.16 Module Management

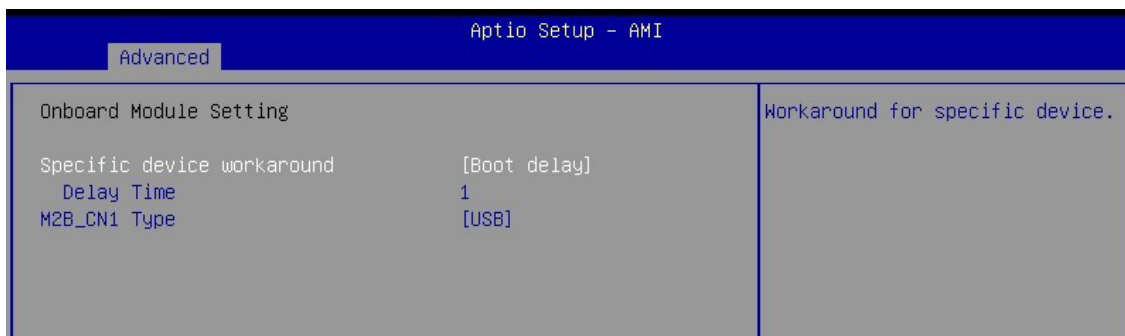

Figure 4-3-16 : Module Management

### Specific device workaround

Workaround for specific device.

### Delay Time

0~255 (second).

### M2B\_CN1 Type

Select M2B\_CN1 Type.

### 4.3.17 SW Ignition Configuration

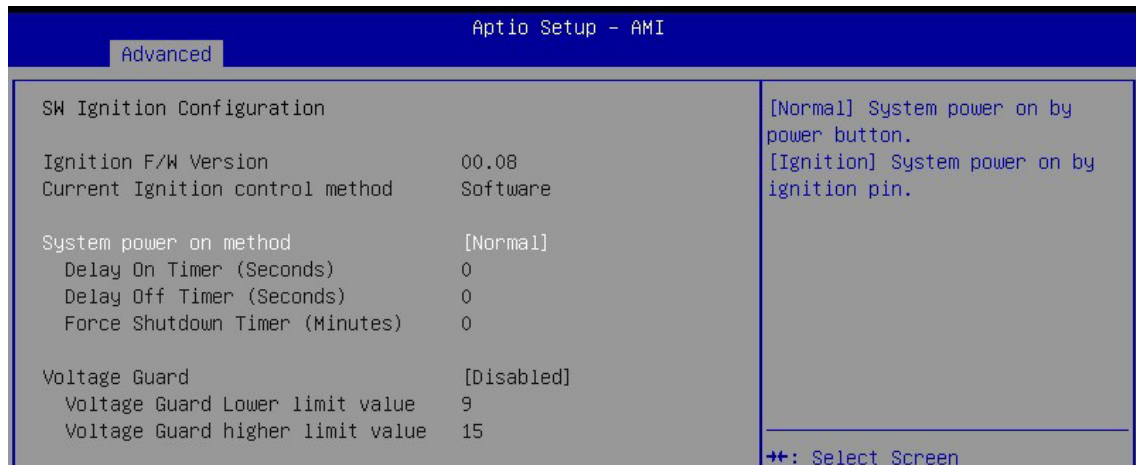

Figure 4-3-17 : SW Ignition Configuration

#### System power on method

[Normal] System power on by power button.

[Ignition] System power on by ignition pin.

#### Delay On Timer (Seconds)

The delay time after user trigger ignition on signal (Seconds).

#### Delay Off Timer (Seconds)

The delay time after user trigger ignition off signal (Seconds).

#### Force Shutdown Timer (Minutes)

Used to force cut off system power when OS unable gracefully shutdown system successfully.

#### Voltage Guard

Voltage Guard enable or disable, only effect on Ignition mode.

#### Voltage Guard Lower limit value

Voltage Guard lower limit value setting. Range: 9v ~ 40v.

#### Voltage Guard higher limit value

Voltage Guard Higher limit value setting. Range: 15v ~ 55v.



## 4.4 Security

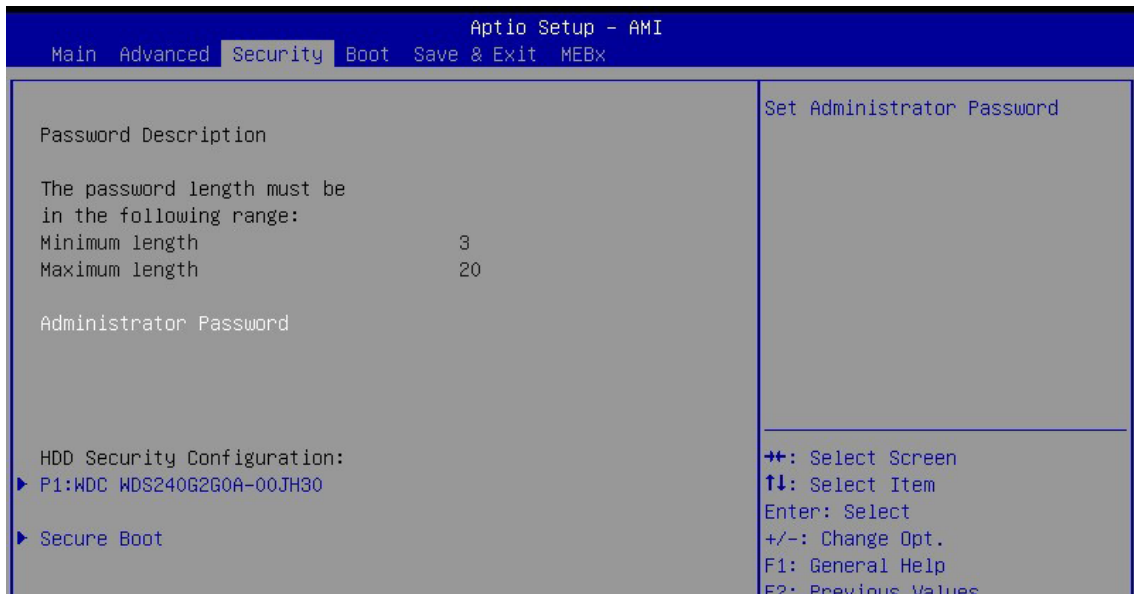

Figure 4-4 : BIOS Security Menu

### Administrator Password

Set administrator password.

### HDD Security Configuration

HDD Security Configuration for selected drive

### Secure Boot

Secure Boot configuration.

## 4.5 Boot Menu

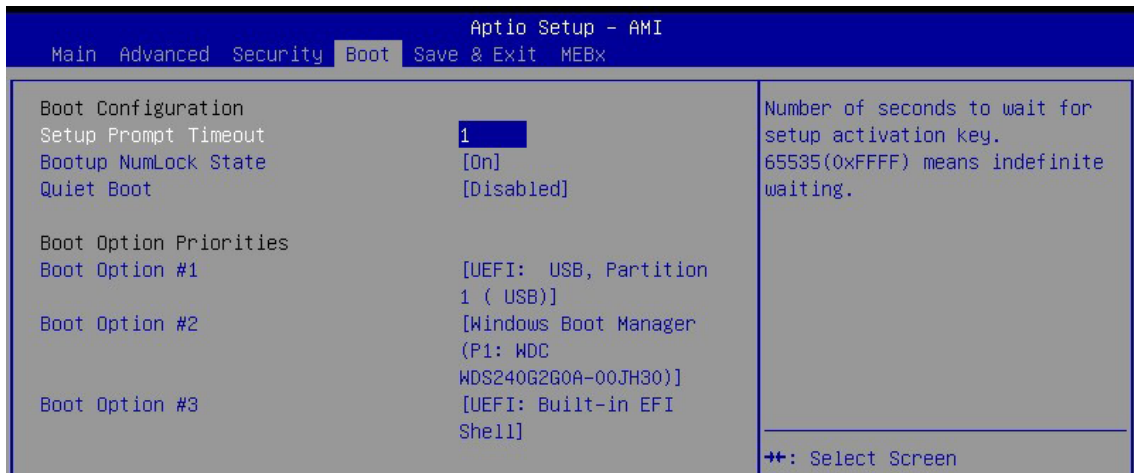

Figure 4-5 : BIOS Boot Menu

### Setup Prompt Timeout

Number of seconds to wait for setup activation key. 65535(0xFFFF) means indefinite waiting.

### Bootup NumLock State

Select the keyboard NumLock state.

### Quiet Boot

Enables or disables Quiet Boot option.

### Boot Option Priorities

Sets the system boot order.

## 4.6 Save & Exit



Figure 4-7 : BIOS Save & Exit

### Save Changes and Reset

Reset the system after saving the changes.

### Discard Changes and Reset

Reset system setup without saving any changes.

### Restore Defaults

Restore/Load Default values for all the setup options.

# A

## APPENDIX A : GPIO GUIDE

### A.1 Function Description

The SPC-9000 offers a 16-bit GPIO a pair of 10-bit internal connector, and a watchdog timer.

GPIO definition is shown below :

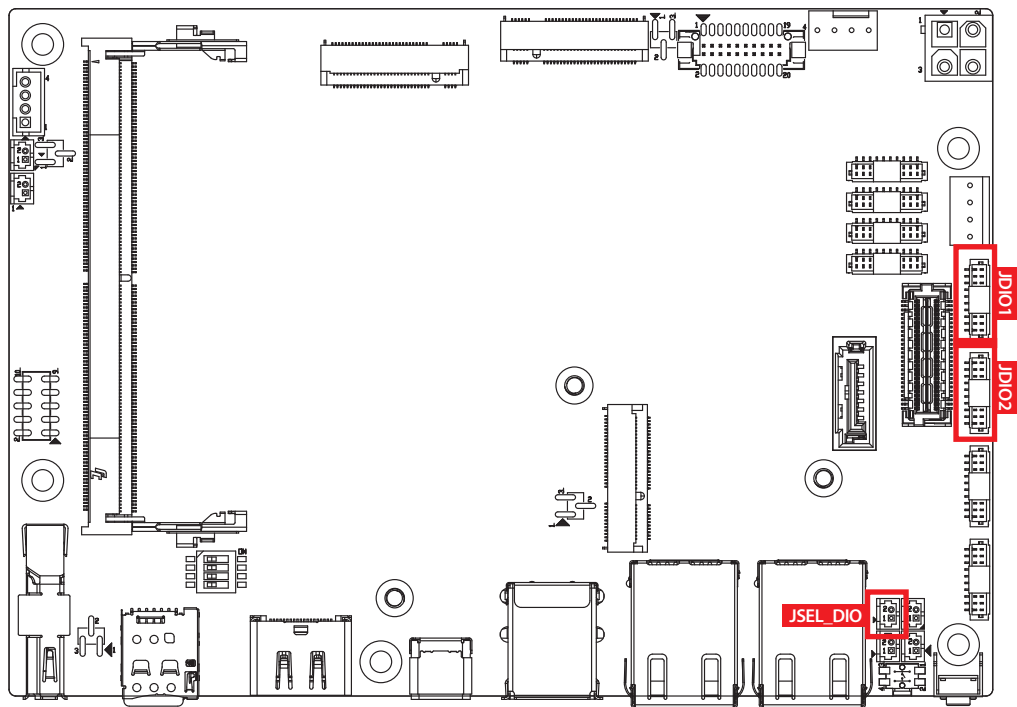

JDIO1		JDIO2	
Pin No.	GPIO Definition	Pin No.	GPIO Definition
1	GPIO 0	1	GPIO 8
2	GPIO 1	2	GPIO 9
3	GPIO 2	3	GPIO 10
4	GPIO 3	4	GPIO 11
5	GPIO 4	5	GPIO 12
6	GPIO 5	6	GPIO 13
7	GPIO 6	7	GPIO 14
8	GPIO 7	8	GPIO 15
9	VDIO	9	VDIO
10	GND	10	GND

## A.2 Software Package Contain

Distribution folders include x32 and x64 versions, use the batch file for driver installation.

There are included as followed :

Win10\_32.bat, and Win10\_64.bat :

Installation for driver, and

Uninstall\_32.bat, and Uninstall\_64.bat :

Uninstallation for driver

Run batch file as Administrator.









Make sure Windows version before installation.

Header folders include head file for software developer or System Integration.

Manual folders include API description.

Sample folders include sample program, driver library, and API library for Windows/Linux

Source folders include sample program source code that compile on Visual Studio 2008/ubuntu16.04.

-  Distribution
-  Header
-  Manual
-  Sample
-  Source
-  Uninstall\_32.bat
-  Uninstall\_64.bat
-  Win10\_32.bat
-  Win10\_64.bat

## A.3 Sample

Execute demo tool.

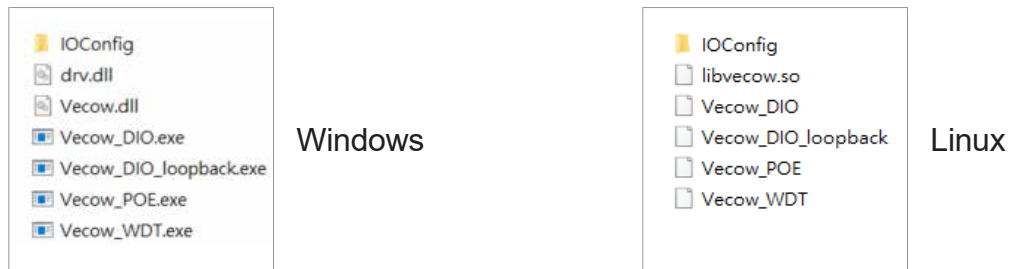

Sample, as shown below :

```
DIO sample version : v1.0.0609.0608
Load Vecow.dll at least v1.8.1409.0608
Vecow.dll Version : v1.8.1409.0608
Config : IO port I - Isolated DIO
         IO port II - Non-Isolated DIO(GPIO)

Choose IO : (1/2)
```

Vecow\_DIO

```
DIO loopback sample version : v1.0.1509.0608
Load Vecow.dll at least v1.8.1409.0608
Vecow.dll Version : v1.8.1409.0608
Config : IO port I - Isolated DIO
         IO port II - Non-Isolated DIO(GPIO)

How many IO temp_port : (1/2)
```

Vecow\_DIO\_loopback

```
POE sample version : v1.0.1609.0608
Load Vecow.dll at least v1.8.1409.0608
Vecow.dll Version : v1.8.1409.0608

Initial POE success!
Usable slave address ID : 0
Select slave address ID :
```

Vecow\_POE

```
WDT sample version : v1.0.0509.0608
Load Vecow.dll at least v1.8.1409.0608
Vecow.dll Version : v1.8.1409.0608
Config : IO port I - Isolated DIO
         IO port II - Non-Isolated DIO(GPIO)

Set WDT timer seconds (1~3932100) :
```

Vecow\_WDT

# B

## APPENDIX B : Software Functions

### B.1 Driver API Guide

In Header folder, Vecow.h and VecowLinux.h contain usable API for Windows/Linux.

#### **BOOL initial\_SIO(BYTE Isolate\_Type, BYTE DIO\_NPN)**

Initial machine for IO and watch dogtimer.

Isolate\_Type : DIO type.

1 : Isolated DIO;

0 : Non-Isolated DIO (GPIO).

DIO\_NPN : DI/DO type.

1 : PNP (Source) mode for European rule;

0 : NPN (Sink) mode for Japanese rule.

Return :

TRUE (1) : Success.

FALSE (0) : Fail (Driver not exists, or version is too old, or machine not match).

#### **BOOL get\_IO1\_configuration(BYTE \*Iso, BYTE \*DI\_mode, BYTE \*DO\_mode, WORD \*Mask)**

#### **BOOL get\_IO2\_configuration(BYTE \*Iso, BYTE \*DI\_mode, BYTE \*DO\_mode, WORD \*Mask)**

Get DIO configuration (by variable)

Isolate\_Type : DIO type.

1 : Isolated DIO;

0 : Non-Isolated DIO (GPIO).

DI\_mode ([7:0]) : DI type, pin setting by hexadecimal bitmask only for Isolated DIO.

0xFF : PNP (Source) mode for European rule;

0 : NPN (Sink) mode for Japanese rule.

DO\_mode : DO type only for Isolated DIO.

1 : PNP (Source) mode for European rule;

0 : NPN (Sink) mode for Japanese rule.

Mask ([15:0]) : In/Out, pin setting by hexadecimal bitmask only for Non-Isolated DIO (GPIO).

1 : Output;

0 : Input

Return :

TRUE (1) : Success.

FALSE (0) : Fail (Initial error, or call by pointer error, or hardware problem).

**BOOL set\_IO1\_configuration(BYTE Iso, BYTE DI\_mode, BYTE DO\_mode, WORD Mask)**

**BOOL set\_IO2\_configuration(BYTE Iso, BYTE DI\_mode, BYTE DO\_mode, WORD Mask)**

Set DIO configuration.

Isolate\_Type : DIO type.

1 : Isolated DIO;

0 : Non-Isolated DIO (GPIO).

DI\_mode ([7:0]) : DI type, pin setting by hexadecimal bitmask only for Isolated DIO.

0xFF : PNP (Source) mode for European rule;

0 : NPN (Sink) mode for Japanese rule.

DO\_mode : DO type only for Isolated DIO.

1 : PNP (Source) mode for European rule;

0 : NPN (Sink) mode for Japanese rule.

Mask ([15:0]) : In/Out, pin setting by hexadecimal bitmask only for Non-Isolated DIO (GPIO).

1 : Output;

0 : Input

Return :

TRUE (1) : Success.

FALSE (0) : Fail (Initial error or hardware problem).

**BOOL get\_DIO1(BYTE \*DO\_data, BYTE \*DI\_data)**

**BOOL get\_DIO2(BYTE \*DO\_data, BYTE \*DI\_data)**

Get isolated DIO output (DO) and input (DI).

DI ([7:0]) : Input state, pin setting by hexadecimal bitmask.

1 : High;

0 : Low.

DO ([7:0]) : Output state, pin setting by hexadecimal bitmask.

1 : High;

0 : Low.

Return :

TRUE (1) : Success.

FALSE (0) : Fail (Initial error or hardware problem).

FALSE (0) : Fail (Initial error or hardware problem).

**BOOL set\_DIO1(BYTE DO\_data)**

**BOOL set\_DIO2(BYTE DO\_data)**

Set isolated DIO output(DO).

DO ([7:0]) : Output state, pin setting by hexadecimal bitmask.

1 : High;

0 : Low.

Return :

TRUE (1) : Success.

FALSE (0) : Fail (Initial error or hardware problem).

FALSE (0) : Fail (Initial error or hardware problem).



**BOOL get\_GPIO1(WORD \*GPIO\_data)**

Get GPIO.

GPIO\_data ([15:0]) : GPIO state, pin setting by hexadecimal bitmask.  
1 : High;  
0 : Low.

Return :

TRUE (1) : Success.  
FALSE (0) : Fail (Initial error or hardware problem).

**BOOL set\_GPIO1(WORD GPIO\_data)**

Set GPIO.

GPIO\_data ([15:0]) : GPIO state, pin setting by hexadecimal bitmask.  
1 : High;  
0 : Low.

Return :

TRUE (1) : Success.  
FALSE (0) : Fail (Initial error or hardware problem).

**BOOL get\_WDT(DWORD \*WDT)**

Get watchdog timer setup.

WDT : watchdog timer setup.  
Unit : second (Range : 0 ~ 65535 sec, 1093 ~ 65535 min (=65580 ~ 3932100 sec)).

Return :

TRUE (1) : Success.  
FALSE (0) : Fail (Initial error, or call by pointer error, or hardware problem).

**BOOL set\_WDT(DWORD WDT)**

Set watchdog timer setup.

WDT : watchdog timer setup.  
Unit : second (Range : 0 ~ 65535 sec, 1093 ~ 65535 min (=65580 ~ 3932100 sec)).

Return :

TRUE (1) : Success.  
FALSE (0) : Fail (Initial error, or setup 0, or hardware problem).

**BOOL cancel\_WDT()**

Cancel watchdog timer.

Return :

TRUE (1) : Success.  
FALSE (0) : Fail (Initial error or hardware problem).

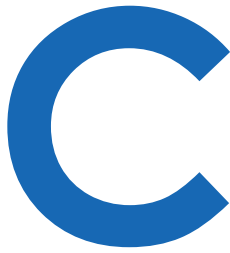

## APPENDIX C : RAID Functions

### C.1.1 VMD Mode for RAID

Please set Enable VMD controller as Enabled on BIOS menu.

Chipset → System Agent (SA) Configuration → VMD setup menu → Enable VMD controller → Enabled → Save Changes and Reset.

1. Select System Agent (SA) Configuration.



2. Select VMD setup menu.

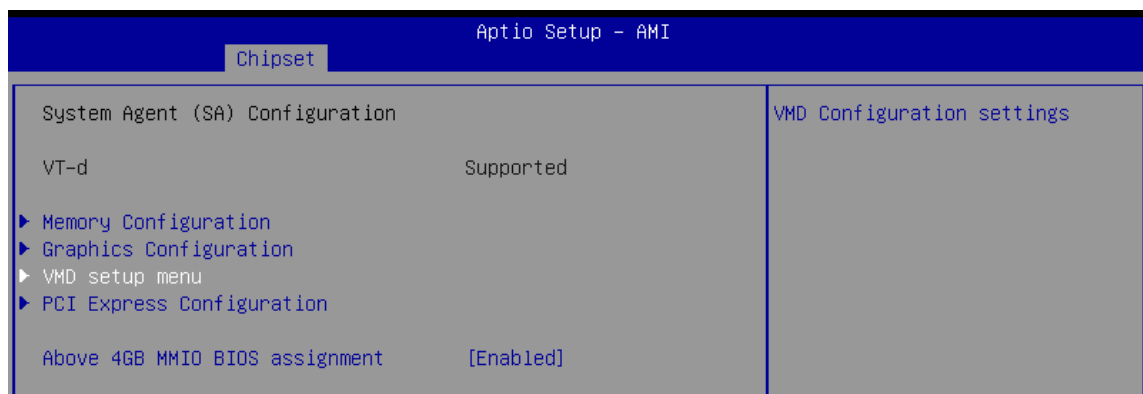

3. Enabled VMD controller. Then Save Changes and Reset.

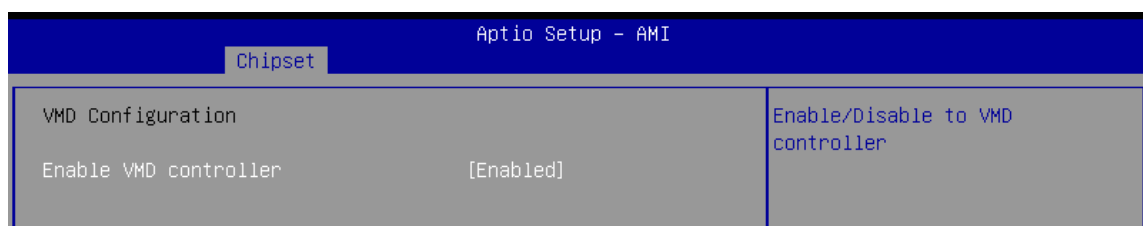

## C.1.2 UEFI Mode for RAID

1. Into BIOS menu again, select Intel(R) Rapid Storage Technology on BIOS menu. Advanced → Intel(R) Rapid Storage Technology.

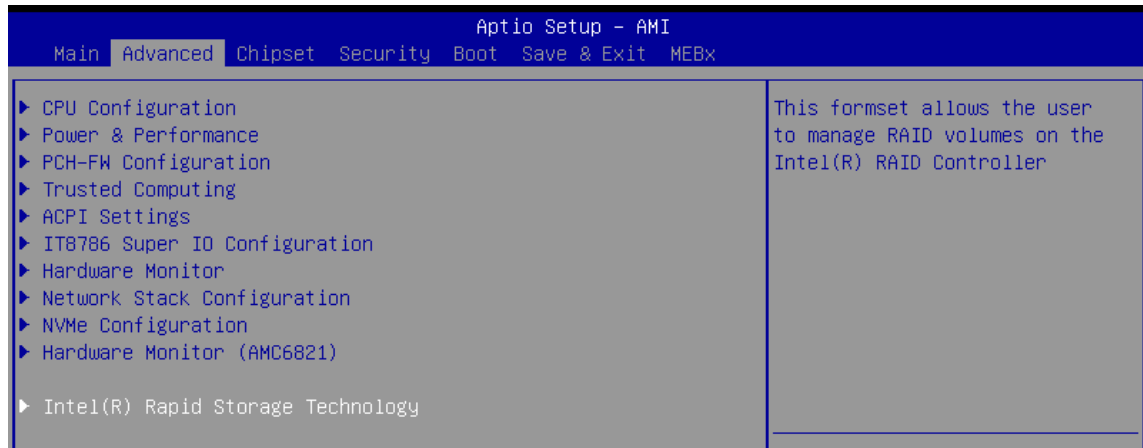

2. Select Create RAID Volume on BIOS menu.

This system is featured 2 M.2 slots for NVMe SSD.

Please note. Storage device M.2 and SATA cannot be mixed to create a RAID Volume.

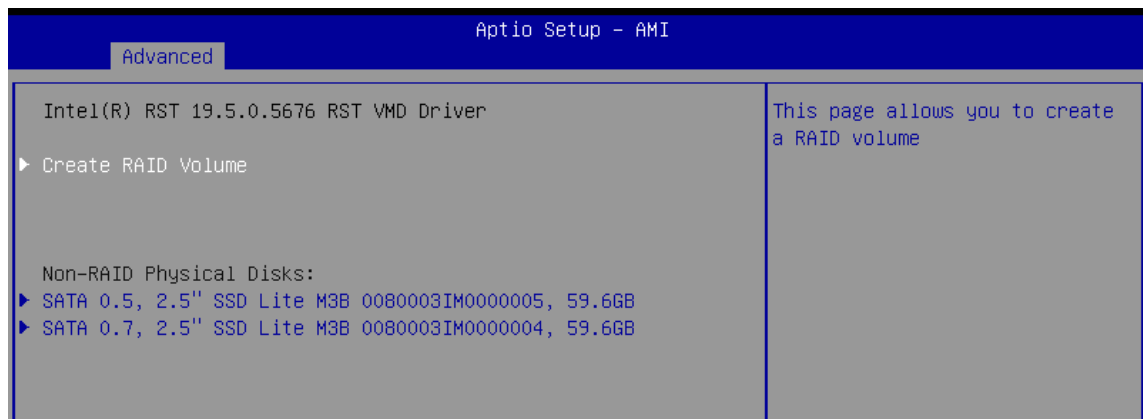

3. Select disks to create RAID Volume, then Save Changes and Reset to install OS.

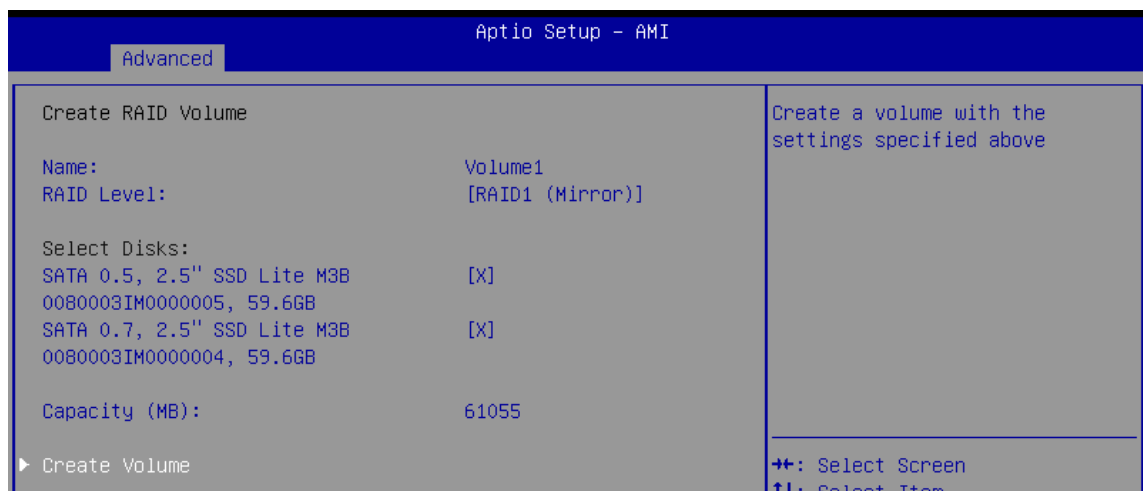

## C.2 OS Installation

This system is featured 2 M.2 slots for NVMe SSD, and 1 SATA slots for HDD.

We used SATA HDD for Windows 10 OS installation as an example.

Please note. After Enabled VMD controller needs to load the IRST driver first before it can read the hard disk.



You can find the latest information and software directly from Intel's website.

[http://www.intel.com/p/en\\_US/support/highlights/chpsts/imsm](http://www.intel.com/p/en_US/support/highlights/chpsts/imsm)

Download driver "SetupRST.exe" and decompress it.

You can refer to Intel official teaching.

<https://www.intel.com/content/www/us/en/support/articles/000094664/technologies/intel-rapid-storage-technology-intel-rst.html>

Open Windows PowerShell or CMD and navigate to the location of the SetupRST.exe file.

Enter the following command to extract:

**./SetupRST.exe -extractdrivers SetupRST\_extracted.**

After extraction, a "SetupRST\_extracted " folder will be created, then put the folder on the USB drive used for installing Windows.

Loading driver and install it when installing Windows.

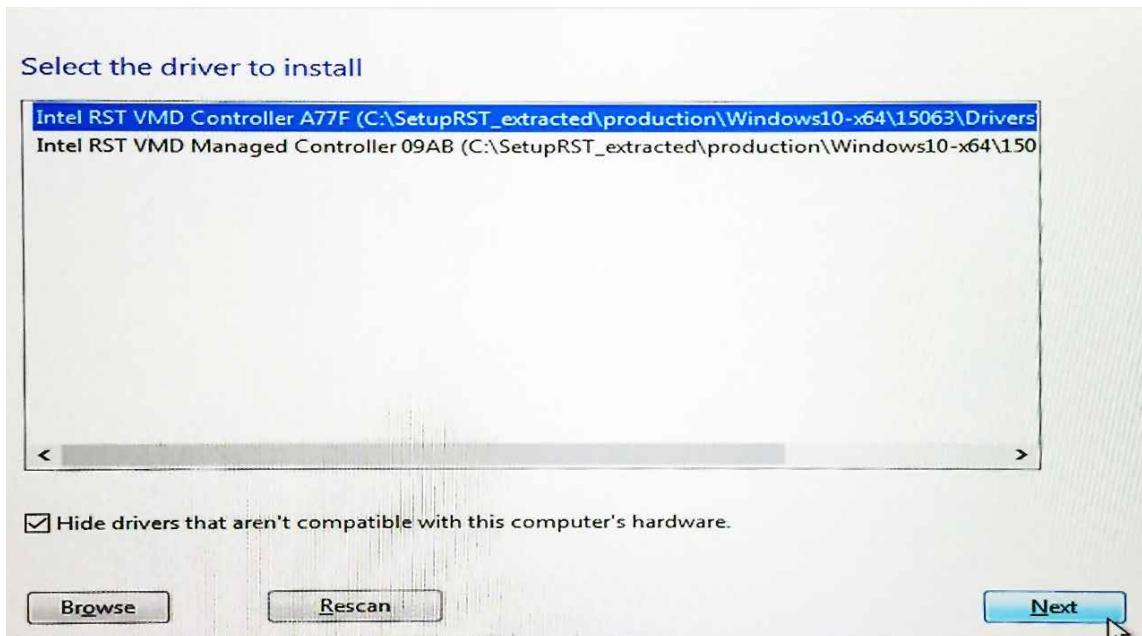
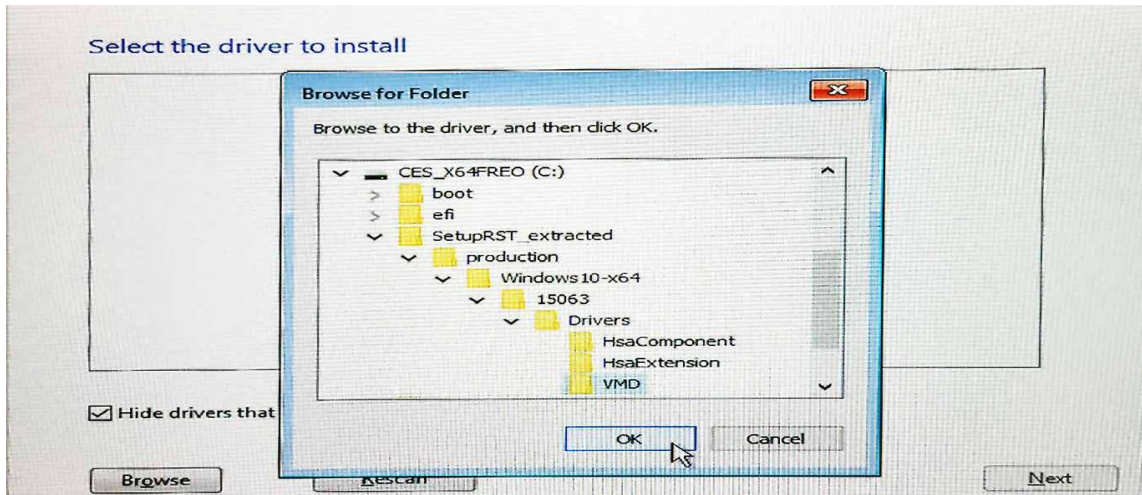

Then you can select the hard drive and install the OS.

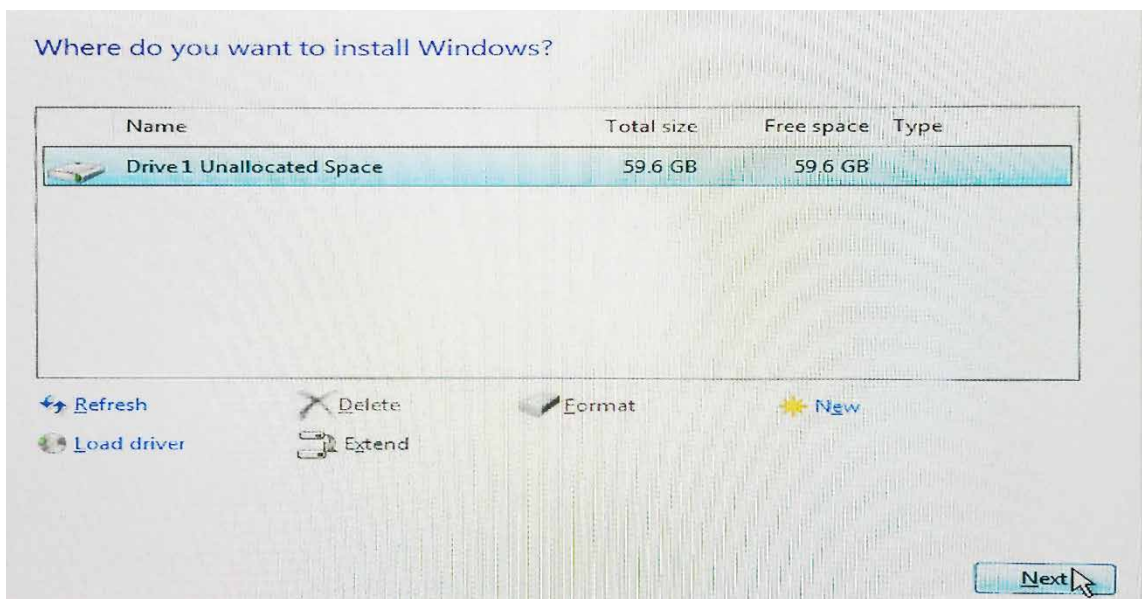

## C.3 To Install All Device Drivers of the System

The instructions are as follows:

1. Install Chipset driver
2. Install VGA driver
3. Install ME driver (if available)
4. Install Network driver
5. Install Audio driver

## C.4 To Install “Intel Rapid Storage Technology” driver

You can get the software from driver CD.

Also, you can find the latest information and software directly from Intel’s website.

[http://www.intel.com/p/en\\_US/support/highlights/chpsts/ims](http://www.intel.com/p/en_US/support/highlights/chpsts/ims)

Install "SetupRST.exe"

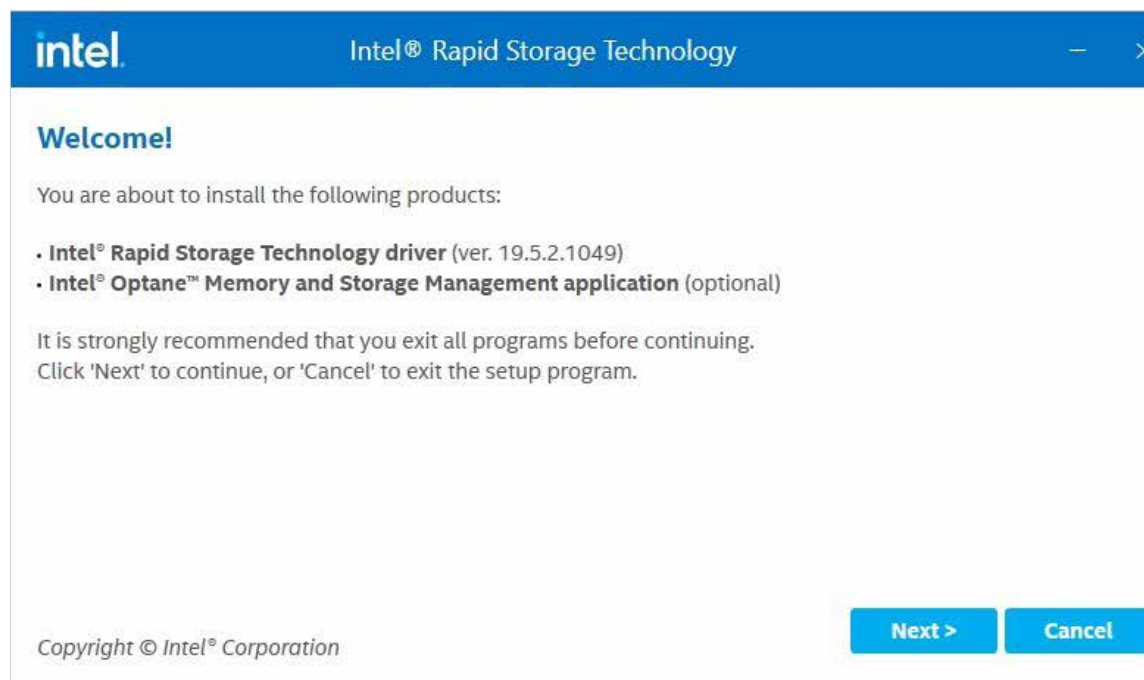

The RAID environment has been done when you completed the steps above.

At this point, the basic RAID Volume setup steps have concluded.

## C.5 Manage RAID Volume on “Intel® Optane™ Memory and Storage Management” Software

You can download "Intel® Optane™ Memory and Storage Management" to manage and create RAID Volumes.

You can find it at Microsoft Store.

<https://apps.microsoft.com/detail/9MZNG5HZWZ1T?activetab=pivot%3Aoverviewtab&hl=en-us&gl=US>

After installation, the created RAID Volume will be displayed here.

The screenshot displays the Intel Optane Memory and Storage Management application window. The title bar reads "intel Intel® Optane™ Memory and Storage Management". On the left is a navigation sidebar with options: Manage, Create RAID Volume, Intel® Optane™ Memory, Performance, Settings, and About. The main content area is divided into sections:

- Status:** A green checkmark indicates "Your storage system is functioning normally."
- Storage System View:** A heading with the instruction "Click on any component below to manage its properties." Below this, a "SATA\_Array\_0000" container shows two "SATA SSD (60 GB)" drives. A blue callout box labeled "Volume1" points to this array, showing "Type: RAID 1" and "60 GB".
- Below the array are two "Internal empty port" entries (ports 4 and 6).
- A "Rescan" button is located at the bottom right of the array section.
- A detailed "Volume1" properties panel is open on the right, showing:
  - Status: Normal
  - System volume: Yes
  - Initialized: No
  - Links: [Rename volume](#), [Initialize](#)
  - Type: RAID 1
  - Link: [Change type](#)
  - Size: 60 GB
  - Write-cache buffer flushing:  Enabled
  - Cache mode: Off
  - Link: [Modify Cache Mode](#)
  - Data stripe size: 64 KB
  - Physical sector size: 512 Bytes
  - Logical sector size: 512 Bytes

## C.6 To Create RAID Volume on “Intel® Optane™ Memory and Storage Management” Software

You can connect additional SATA devices to build RAID Volumes, and use "Intel® Optane™ Memory and Storage Management" Software for management.

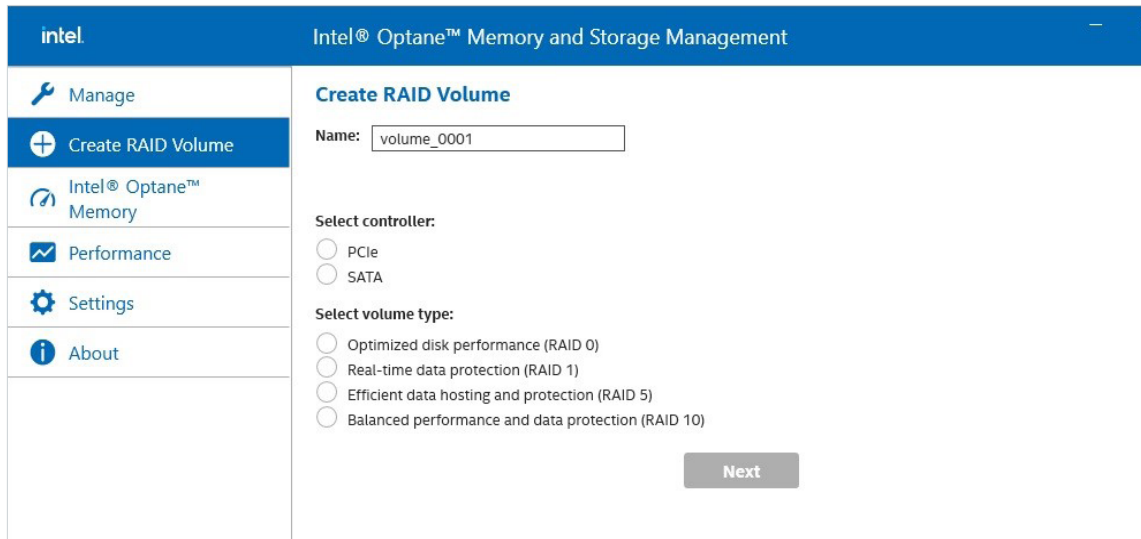

The screenshot displays the Intel Optane Memory and Storage Management software interface. The title bar reads "intel Intel® Optane™ Memory and Storage Management". On the left is a navigation menu with the following items: "Manage", "Create RAID Volume" (highlighted), "Intel® Optane™ Memory", "Performance", "Settings", and "About". The main content area is titled "Create RAID Volume" and contains the following fields and options:

- Name:** A text input field containing "volume\_0001".
- Select controller:** Two radio button options: "PCIe" and "SATA".
- Select volume type:** Four radio button options: "Optimized disk performance (RAID 0)", "Real-time data protection (RAID 1)", "Efficient data hosting and protection (RAID 5)", and "Balanced performance and data protection (RAID 10)".
- Next:** A grey button located at the bottom right of the configuration area.



# D

## APPENDIX D : Power Consumption

### D.1 SPC-9000/9100/9200

Testing Board :	SPC-9000/9100/9200
RAM	32GB * 1
USB-1 : (USB 3.0)	USB Mouse ACER MOAMUOA
USB-2 : (USB 3.0)	USB Keyboard Logitech G-100 GameingKeyboard
SATA 0	Apacer AS340X 120GB SSD
LAN 1 (i226)	2.5 Gbps
LAN 2 (i226)	2.5 Gbps
Graphics Output	DP
Power Plan	Balance (Windows10 Power plan)
Power Source	Chroma 62006P-100-25
Test Program	BurnInTest V10.2 Pro

## D.2 Intel® Core™ Ultra 7 processor 165U 2.1GHz (12M Cache, up to 4.90 GHz)

CPU	Power Input	Standby Mode		Power on and boot to Win 10 (64-bit)			
				Sleep Mode		idle status CPU usage less 3%	
		Max Current	Max Consumption	Max Current	Max Consumption	Max Current	Max Consumption
Core™ Ultra 7 processor 165U	9V	0.434A	03.906W	0.681A	06.129W	1.210A	10.89W
	12V	0.361A	03.361W	0.543A	06.516W	0.954A	11.448W
	24V	0.218A	05.232W	0.329A	07.896W	0.491A	11.784W
	55V	0.132A	07.26W	0.191A	10.505W	0.274A	15.07W

CPU	Power Input	Power on and boot to Win10 (64-bit)			
		Run 100% CPU usage with 2D		Run 100% CPU usage with 3D	
		Max Current	Max Consumption	Max Current	Max Consumption
Core™ Ultra 7 processor 165U	9V	2.933A	26.397W	3.027A	27.243W
	12V	2.203A	26.436W	2.286A	27.432W
	24V	1.138A	27.312W	1.154A	27.696W
	55V	0.525A	28.875W	0.568A	31.24W

# E

## APPENDIX E : Supported Memory & Storage List

### E.1 Test Item

Testing Board	SPC-9000/9100/9200
Memory Test	MemTest86 V11.0

Channel	Memory Test	OS internal info	Hibernate	Reboot
*1 (DIMM 1)	PASS	PASS	PASS	PASS

### E.2 Supported Non-ECC Memory List

Brand	Info	Test Temp.(Celsius)
Transcend 8G DDR5-5600 SO-DIMM	TS1GSA64V6G	25
Samaung 16G DDR5-5600 SO-DIMM	M425RGA3PB0-CWM0D	25
Innodisk 32G DDR5-5600 SO-DIMM	M5S0-BG2OCZQ-H03	25

### E.3 Supported ECC Memory List

Brand	Info	Test Temp.(Celsius)
Transcend 32G DDR5-5600 EC4 SO-DIMM	TS4GSA72V6E	25

## E.4 Supported Storage List

Type	Brand	Model	Capacity
SATA SSD	innodisk	3ME4 DES25-A28M41BW1DC-H03	128GB
	Transcend	TS512GSSD460K	512GB
	innodisk	3TE7 DES25-C12DK1KCCQL-H03	512GB
M.2 PCIe SSD	innodisk	4TG2-P DGM28-C12DP1KCAEF-H03 G4X4	512GB
		3TE6 DEM28-C12DD1KCCQF-H03 G3X2	512GB
	Transcend	TS512GMTE720T G4X4	512GB
		TS512GMTE460T	512GB
M.2 SATA SSD	SMART	FDM28256GTCYC282 SATA 6G	256GB
	Innodisk	3TE7 DEM28-C12DK1KCAQL-H03	512GB

\*\* If more help is needed, please contact Vecow Technical Support.



For further support information, please visit [www.vecow.com](http://www.vecow.com)

This document is released for reference purpose only.

All product offerings and specifications are subject to change without prior notice.

No part of this publication may be reproduced in any form or by any means, electric, photocopying, or recording, without prior authorization from the publisher.

The rights of all the brand names, product names, and trademarks belong to their respective owners.

© Vecow Co., Ltd. 2024. All rights reserved.